

This document describes the new features and improvements introduced in the TYPE EDIT Version V14 software.

With this new version, our team has strived to give you more tools to control the design as well as a general optimization of our toolpaths for increased productivity. And of course, new parameters to go even further in machining.

TYPE EDIT is now organized under 3 logical and distinct module names: 2D drawing (**TYPE CAD**), 3D design (**TYPE ART**) and CAM (**TYPE CAM**).

## TYPE CAD

### 1. SVG ICONS, NEW INTERFACE

All TYPE EDIT icons are now in SVG vector format. This format allows you to have sharp icons whatever the size of your screen. The size of the icons to be displayed is set in the **“Options”**

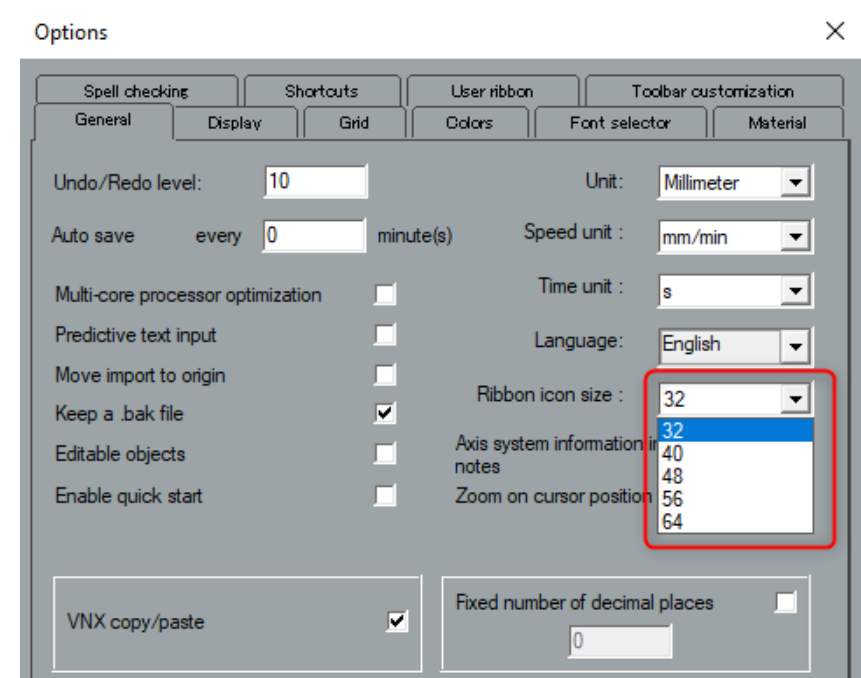

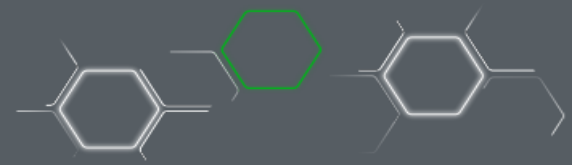

The icons in the different sizes remain clear: the resolution of your screen will be considered.



: 100 %



: 200 %

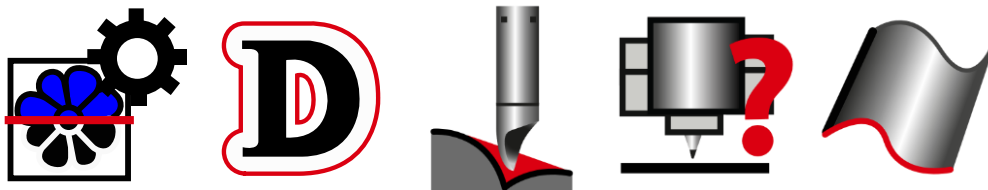

: 300 %

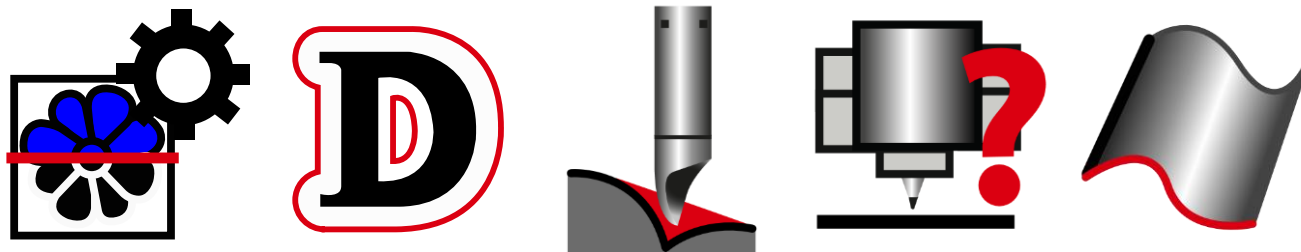

: 400 %

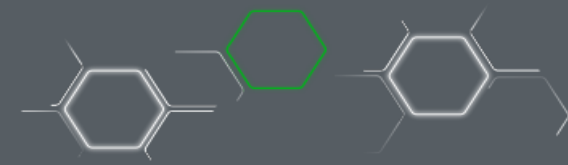

We also took the opportunity to change and modernize the interface by making it simpler, more ergonomic and relaxing with a darker environment while keeping the efficiency you knew.

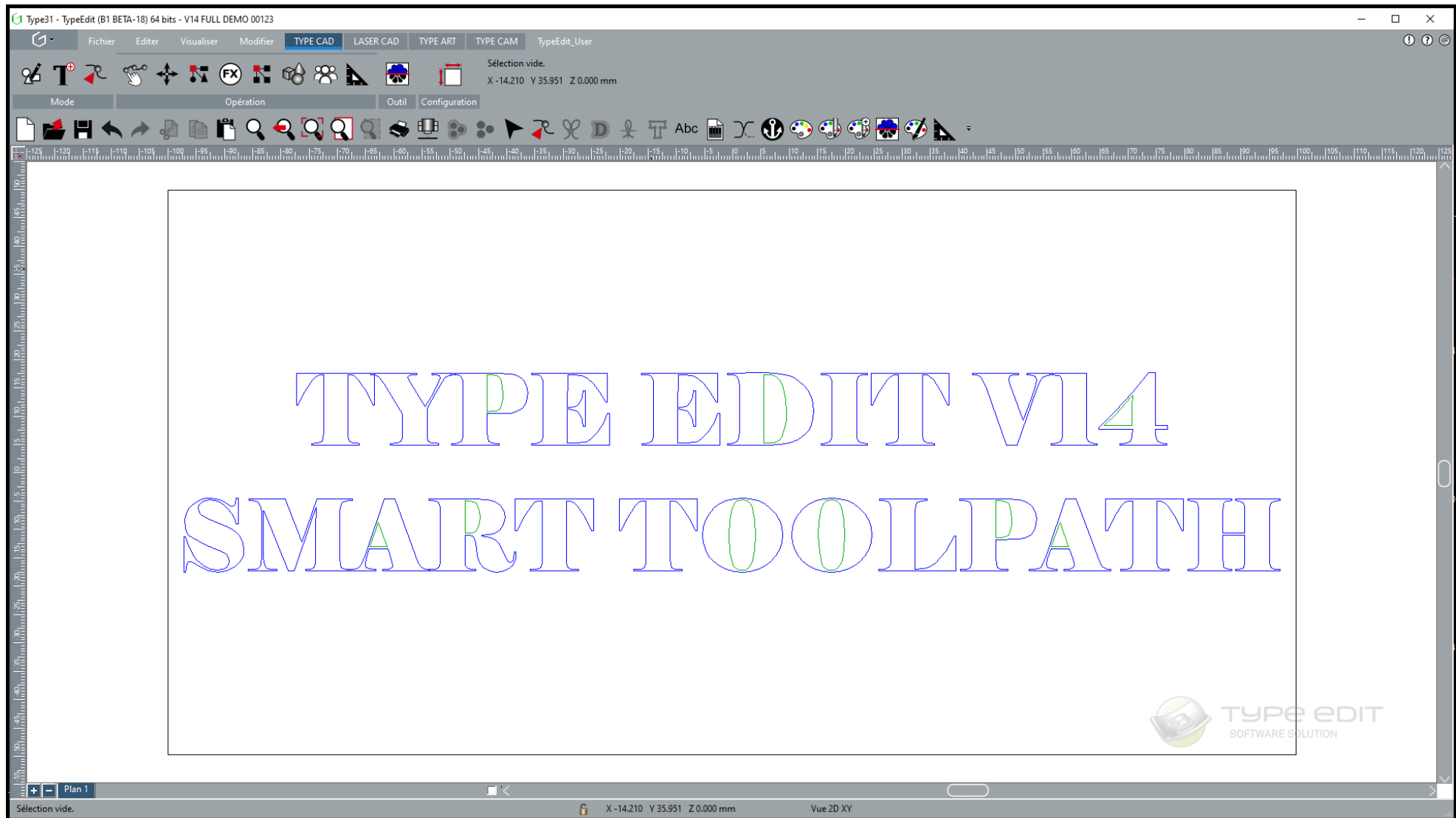

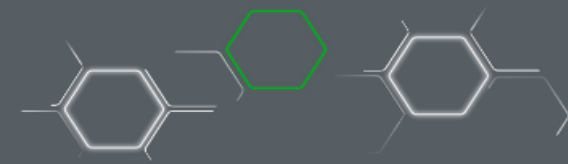

## 2. 64 Bit and Unicode



The introduction of 64 bits will offer the possibility to manage much more data, such as importing a larger vector file, calculating a toolpath with more vectors, or creating a 3D TYPE ART model with better resolutions.

**!** Note: 64-bit does not imply faster calculations but only the management of more data. The master will be also 64 bit.

Unicode compatibility will give more flexibility to all our customers using languages such as Russian, Japanese, Korean, Chinese, etc.

It is no longer necessary to change the Windows Regional Options and restart your PC. You just need to change the language in the **“OPTIONS”** and restart your software.

The file names, the imported or written texts and the interface texts will be totally managed, the display will be correct and in the specifics of your language of use.

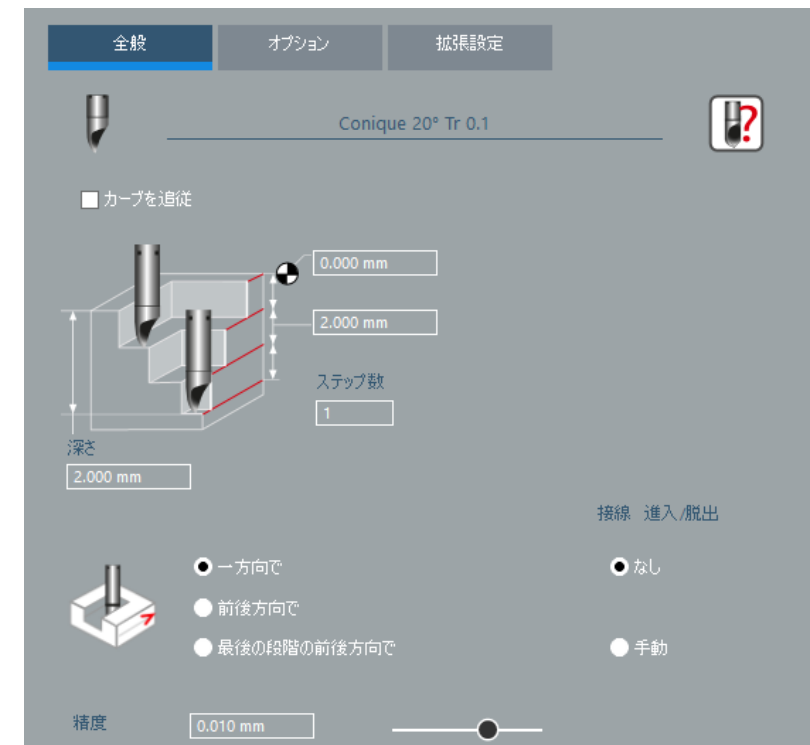
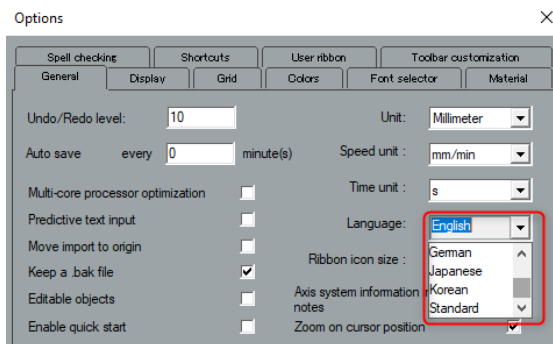

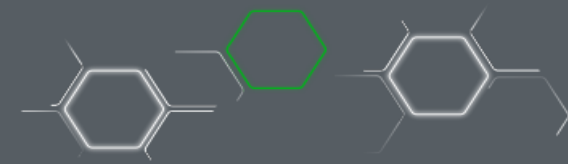

### 3. EXPORT

#### A. NEW : IMPORT



As for each version, we improve our import speeds, vector formats such as DXF, DWG, PDF are even faster and thanks to our new library, more entities can be imported and recognized by the software.

It is now possible to import the \*.SVG (Scalable Vector Graphics) format which is widely used in many web applications to display vectors.

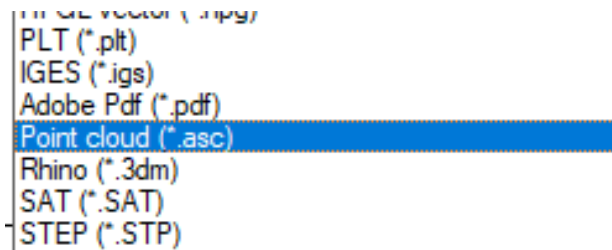
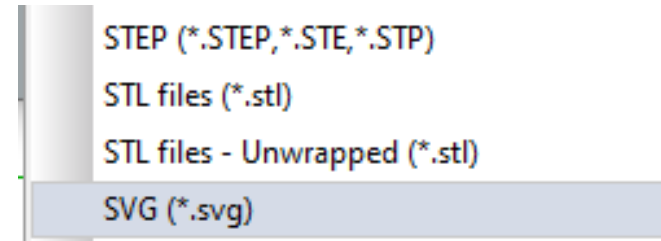

#### B. NEW : EXPORT cloud of points

To make our 3D model, TYPE ART, even more compatible with third-party software, you can now export them as cloud of points with only X, Y, Z coordinates. With this format, we assure you no distortion of your model.

X	Y	Z
38.0387	48.1342	-1.7442
38.0945	48.1342	-1.7159
38.1503	48.1342	-1.6876
38.2061	48.1342	-1.6592

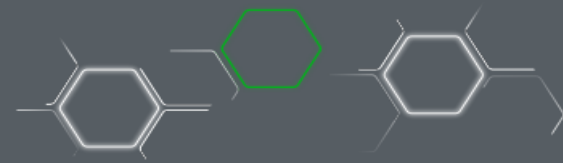

## 4. NEW : unifie extension format

---

We decided to reunite the extensions of our files between TYPE EDIT (\*.VND) and LASER TYPE (\*.VNL). The new format, from version V14 is \*.GVT.

The immediate gain for you who have the 2 software solutions is the possibility to open any file whatever your initial creation software. Drag and Drop in the window also works and will open the file.

 Note1 : V14 can open both VND and VNL files and save them in the new GVT format.

 Note2 : older versions of TYPE EDIT or LASER TYPE continue to open their respective formats but will not be able to open a GVT file.

In conclusion : \*.VND et \*.VNL → \*.GVT

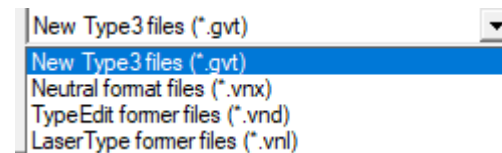

## 5. Languages

---

The available languages are the following from build 1 :

- French, English, German, Spanish, Italian, Russian, Japanese, Korean, Chinese, Czechs, Hungary

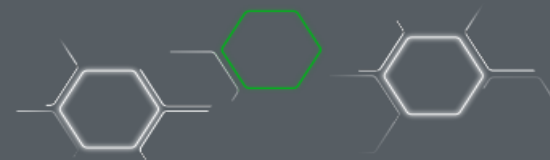

## 6. NEW : "LINE" function

This very basic function was missing from our geometrical shape's catalog. You can find it in the "Geometric Shapes" toolbar.» .

Here it is with its parameters, by clicking on F2 at the same time as the icon. You can enter the length / angle and the start and end points. Freehand drawing with 2 clicks is also possible..

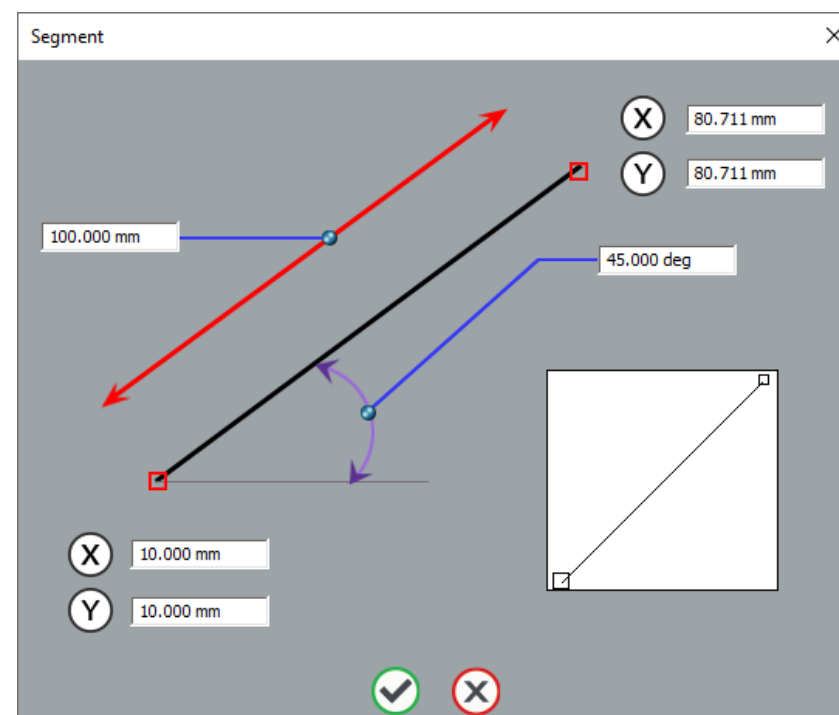

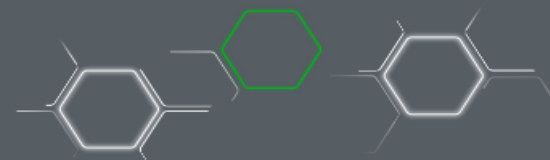

## 7. 7. NEW: Function "DELETE ALIGNED POINTS". "

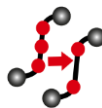

This is a very interesting function that allows, as its name suggests, to delete aligned points. It can be found in the "Special Effects" toolbar.

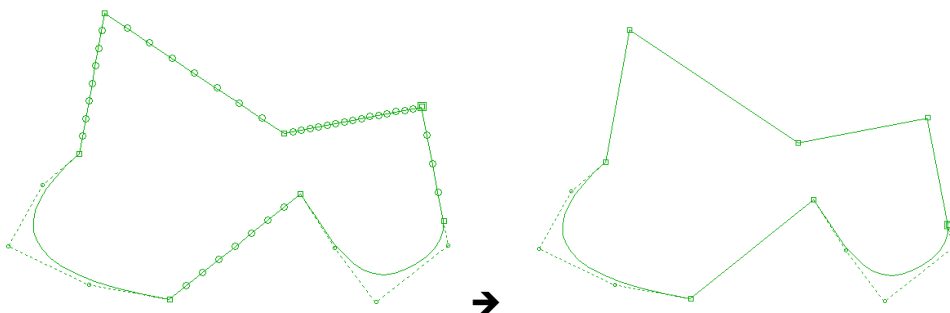

All intermediate aligned points between two ends will be erased according to a tolerance. Very useful after a vectorial import whose curves are all segmented. The goal is to minimize the number of points for machining or 3D construction.

**!** Note : Our "Knives", "Offset" and "Offset to follow" functions also benefit from this approach.

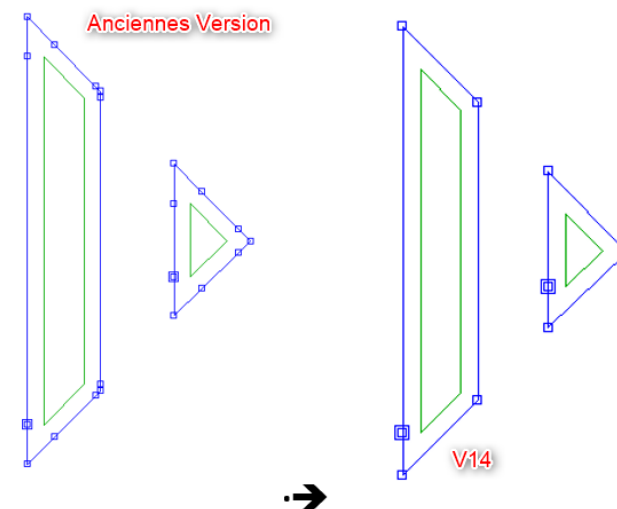



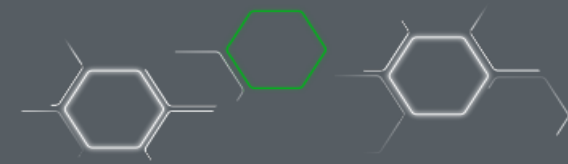

## 8. NEW : BRAILLE function



This Braille wizard has been developed to simplify the process for you. Just type your text and select one of the 53 Braille possibilities according to the country. The function can be found in the "Specific functions" toolbar. 

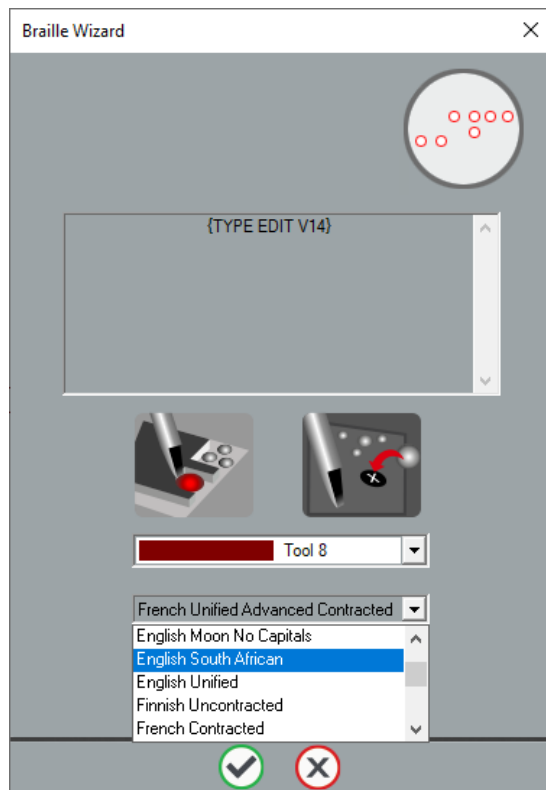

Braille is a writing/reading system made up of tactile dots used by people who are visually impaired or blind.

Each Braille character or cell is obtained from 2 columns of 3 dots each. By combining relief and flat dots, 64 cells are obtained from 6 dot locations.

Braille Wizard transcribes a word into Braille equivalent according to the standards in force in the selected country.

The Braille Wizard uses the TTF NH-Braille font to display the cells. If the font is not installed on your computer, a message will warn you when you run TYPE EDIT.



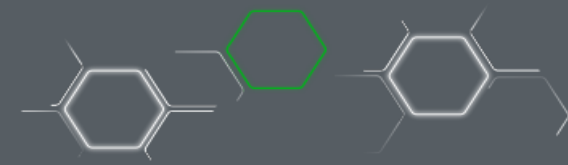

## 9. IMPROVEMENT: EXAMPLE TEXT DISPLAY Bigger

The font selection display is much larger for a better visualization of the shapes. If you need to recognize the font used for your curves then this new display will help you.

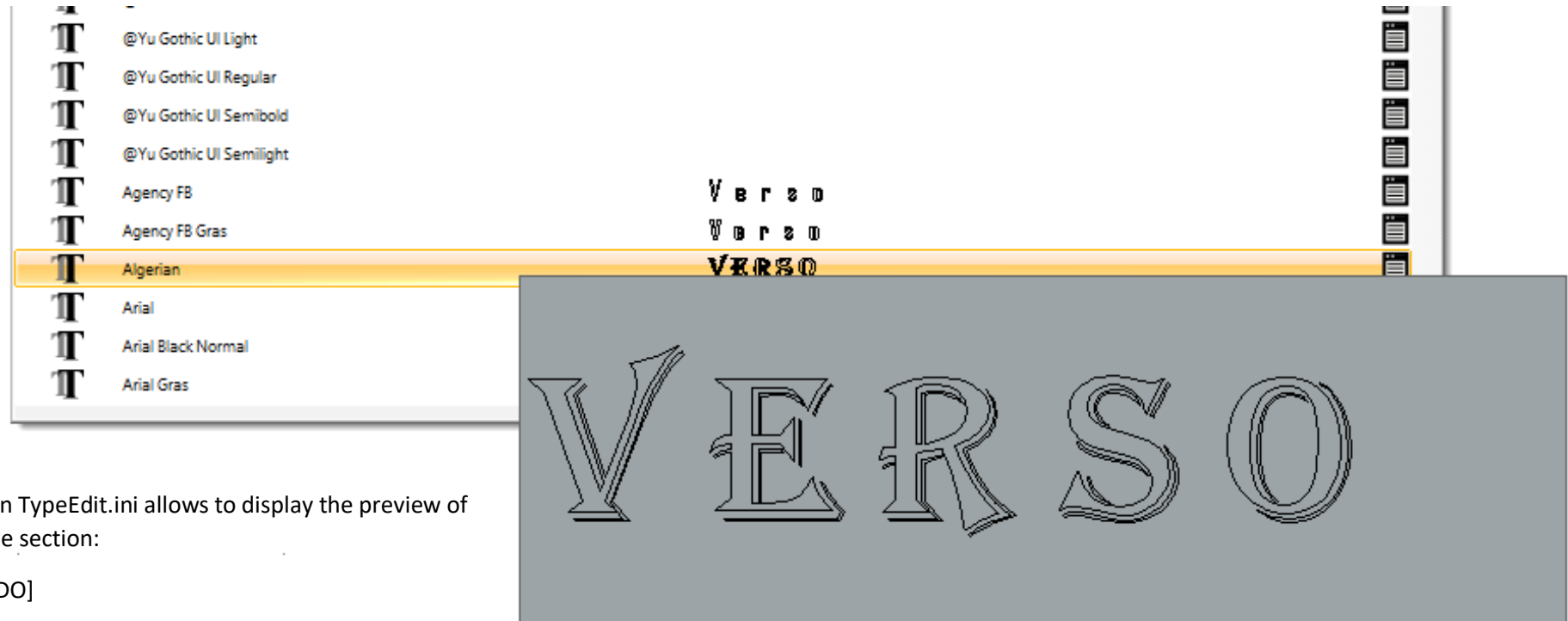

Parameters in TypeEdit.ini allows to display the preview of the text in the section:

[FONT\_RAPIDO]

WidthDisplay=700                      Width of the window

FontHeightFamille=18                  Height of font families

FontHeight=12                          Font height

 : You can enlarge the height of the window manually.



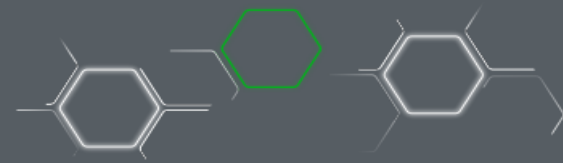

## TYPE ART

In this 3D module, TYPE ART, we have worked a lot to make the design more interactive by totally modifying the display but also introduce, progressively, the possibility to visualize the result during the creation with a "Compute" button.

In addition, with 64-bit compatibility, the resolution of our 3D models has been doubled by default.

### 1. NEW : Curve sweeping



This is a new possibility of curve sweeping, which TYPE EDIT offers you, among already 6 other existing methods, in our catalog. This new sweeping makes it possible to obtain even more astonishing results, even impossible to obtain with other methods or applications, especially in angular corners.

Take a look or admire, earlier, in the corners the effect obtained. The junction is perfect and harmonious.

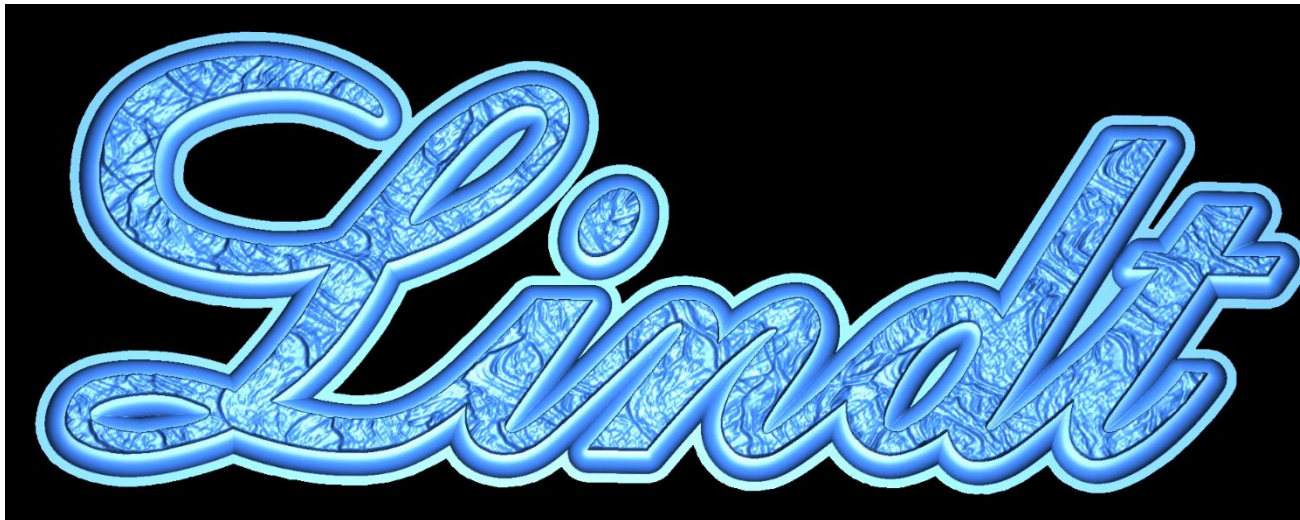

The operation is quite simple to use, you must select the support then the section before starting the function. Sweeping respect the contour directions (clockwise or counterclockwise).

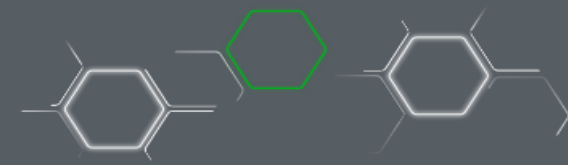

## 2. NEW : 3D VIEWER

A new 3D rendering freshly developed by our teams to give you a more concrete reality of your 3D modeling under TYPE EDIT.

A new window opens automatically as soon as you are in the 3D TYPE ART module. It is independent or not according to the Options and you can move it and/or resize it as you wish. If, in addition, you have a second screen, your working comfort will be improved because you can on one side select curves and launch functions while monitoring the 3D result on the other screen simultaneously.

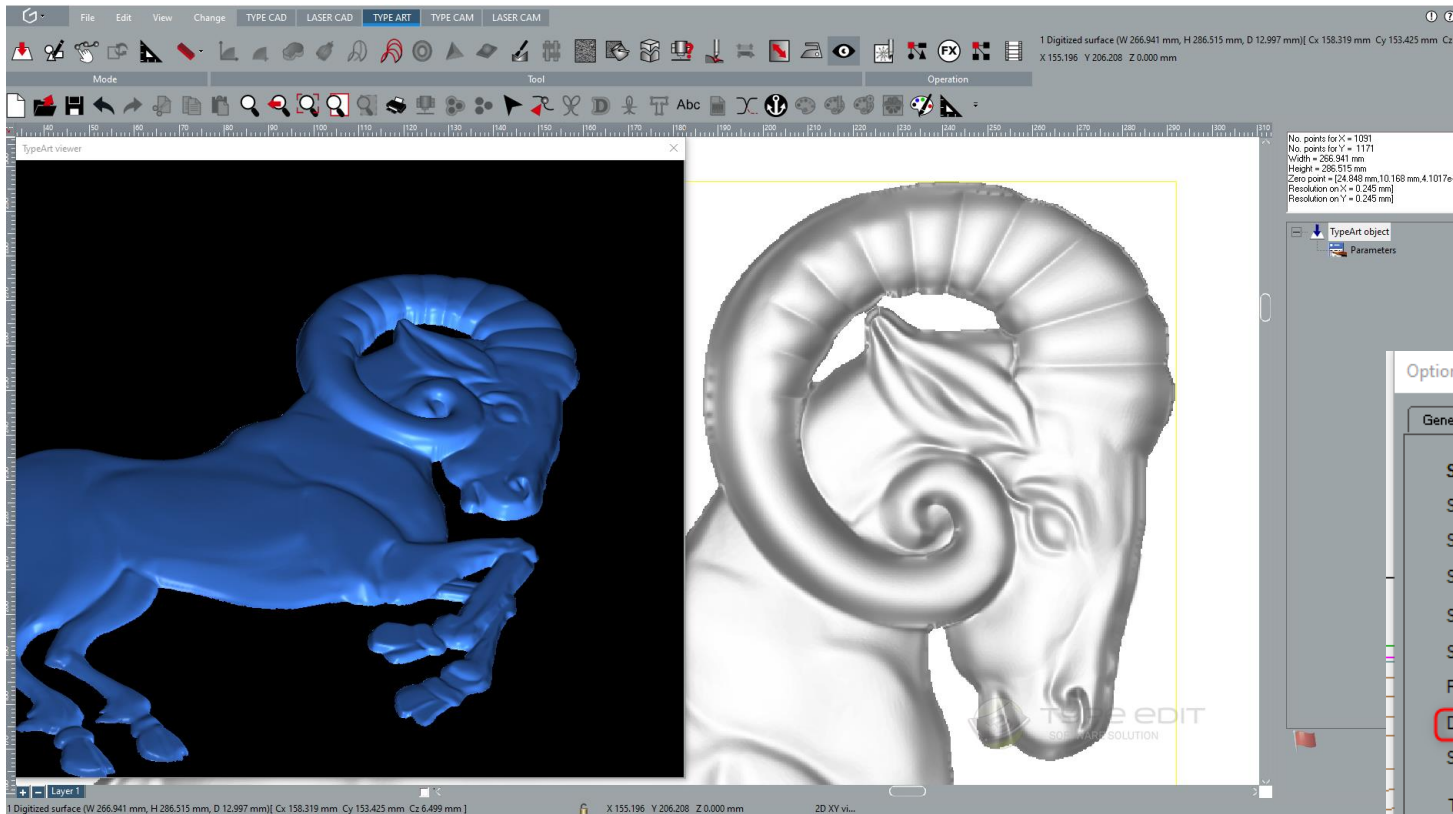

We use dynamic rendering in OpenGL

Locking the 3D rendering window is possible in "Display Options"

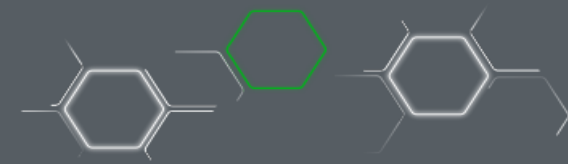

The Rendering parameters :

- A. Modify the color in a palette as well as the associated parameters such as opacity, scattering coefficients, specular, etc.
- B. Load an image that will be bump mapped on your model.
- C. Quickly change the basic views: XY, YZ, XZ and 3D
- D. Changing the position of the lighting

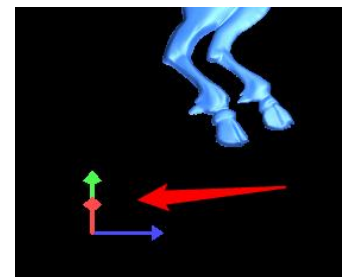
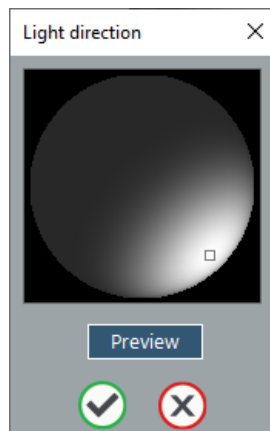
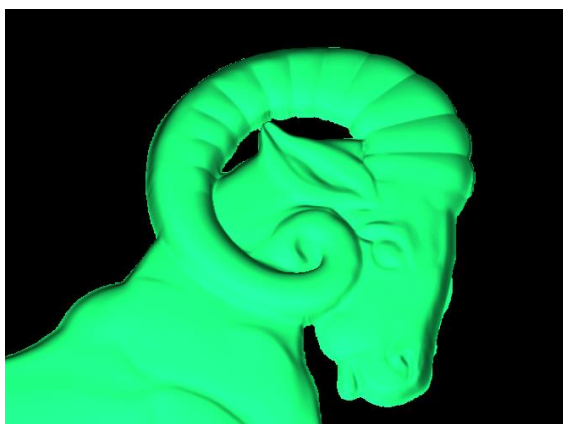
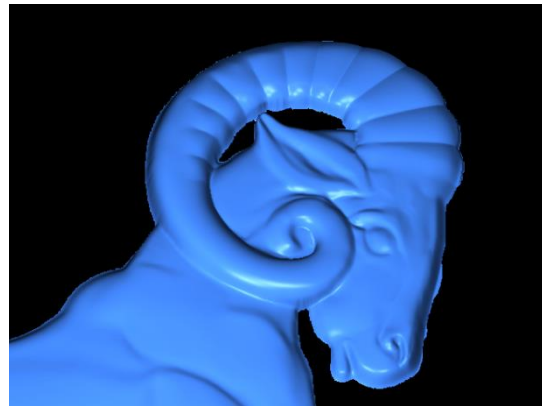

A local reference system locates you in the 3D space.

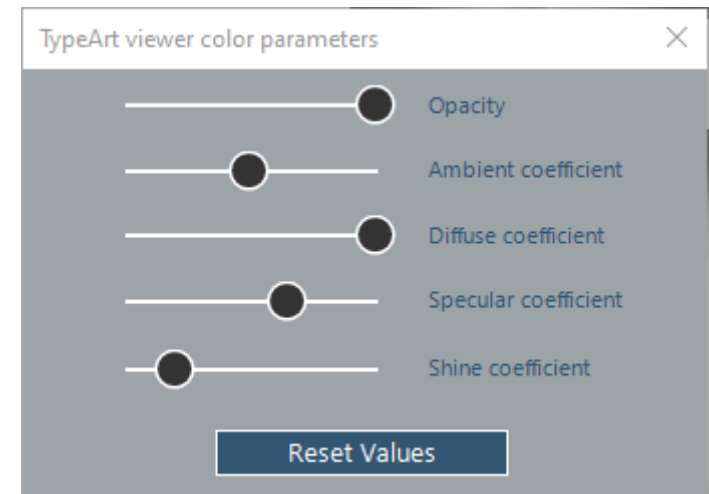
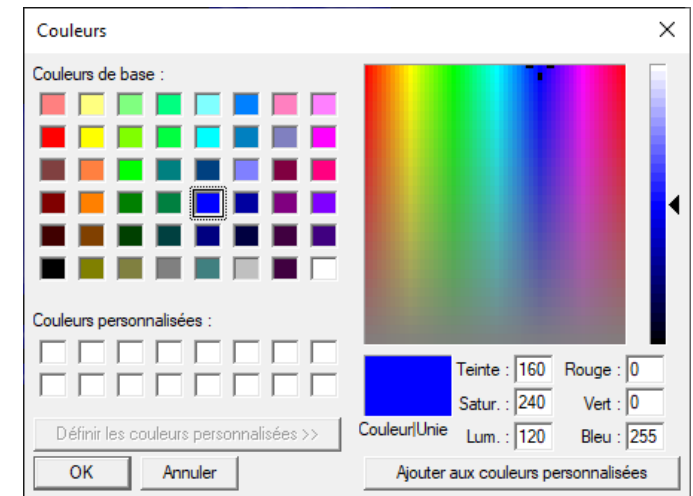
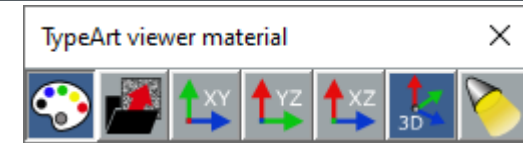



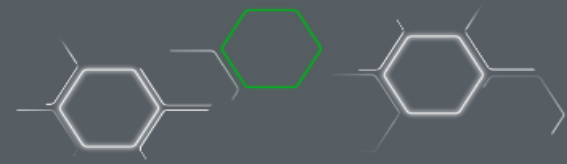

Example of images proposed during the installation, but you can of course use your own, please take images of good resolutions and square images to avoid distortions:

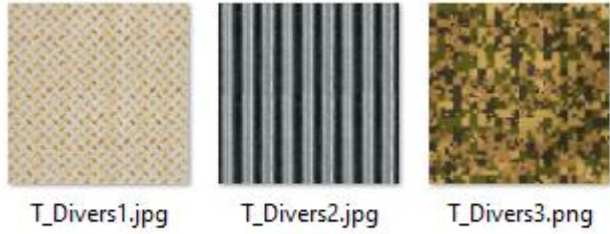

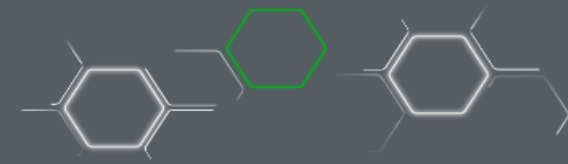

### 3. NEW : Z position of the 3D model

On the 2D view on the right, only, move your mouse over your shape to know the Z value. An important information to control the depth of your model at any time.

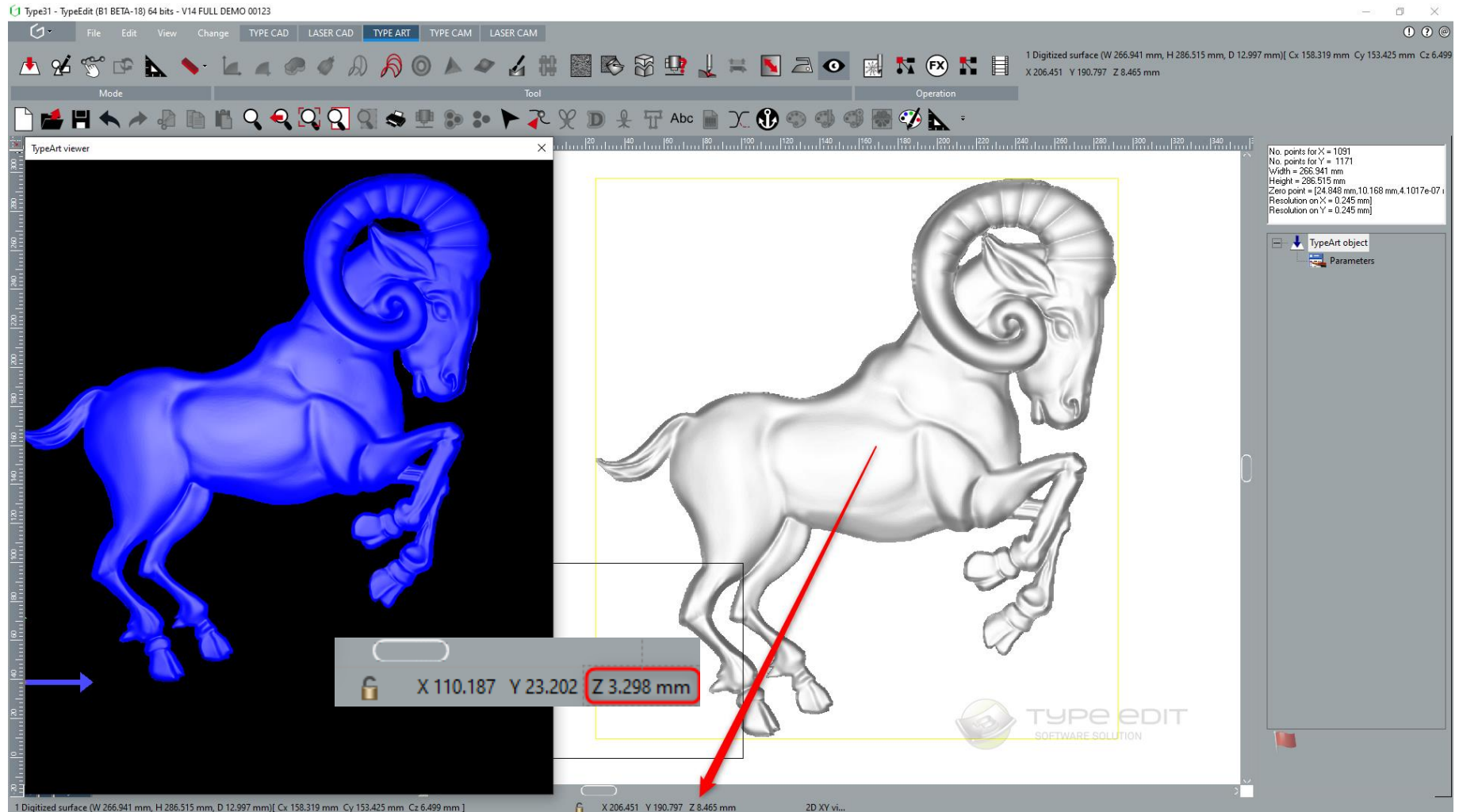

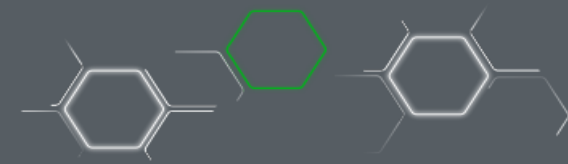

#### 4. COMPUTE « button »

The main idea is to visualize the result in the 3D Viewer or 2D view before leaving the function.

Operating principle on the Symmetric Curve function.

Select the curves then launch the function. Choose the parameters then click on "**Compute**", the result is displayed on the 3D Viewer as well as the 2D view. The result is suitable for you then press on "OK" to validate. If not, you must

undo the action  to cancel your parameters and then modify the combination mode or choose other values and then "**Compute**". You can then modify the parameters ad infinitum to really get what you have in mind.

We will gradually bring this approach to all functions in the TYPE ART module.

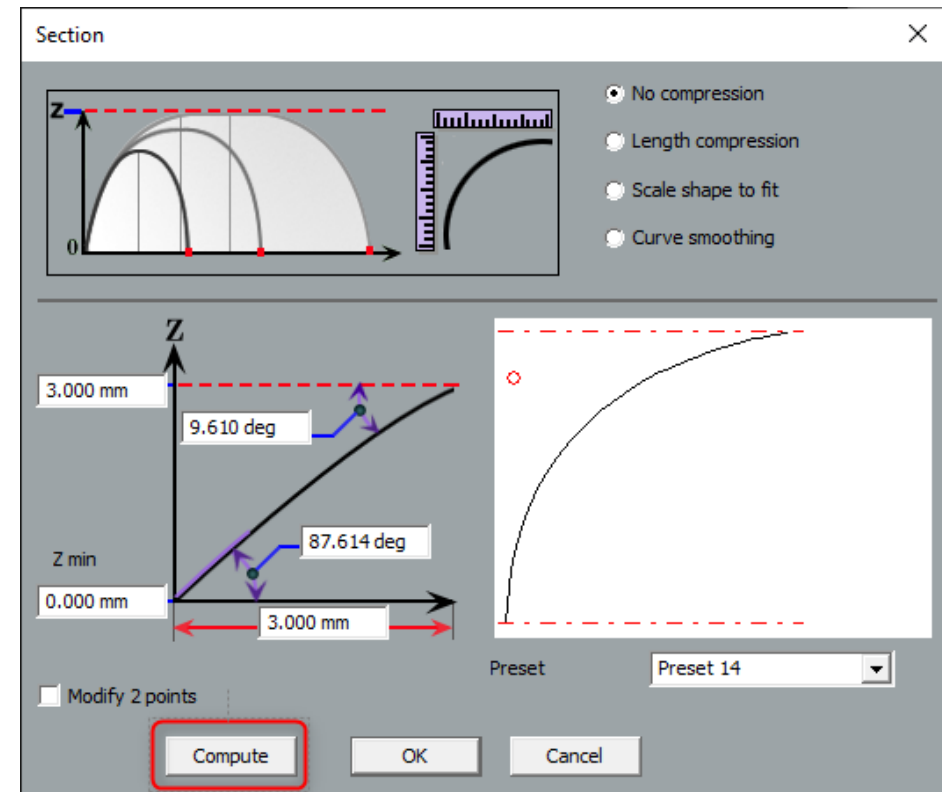



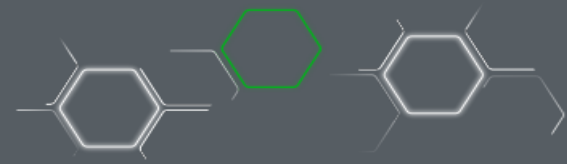

## 5. "SMOOTH" option during grayscale conversion

When you convert a grayscale into a 3D model, it is now possible to apply a "smoothing" to reduce the grains.

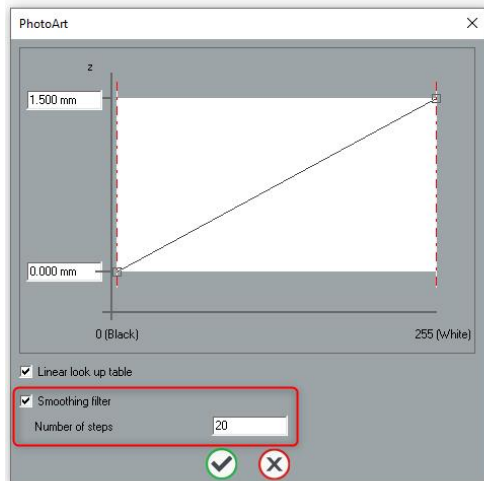

Without smoothing

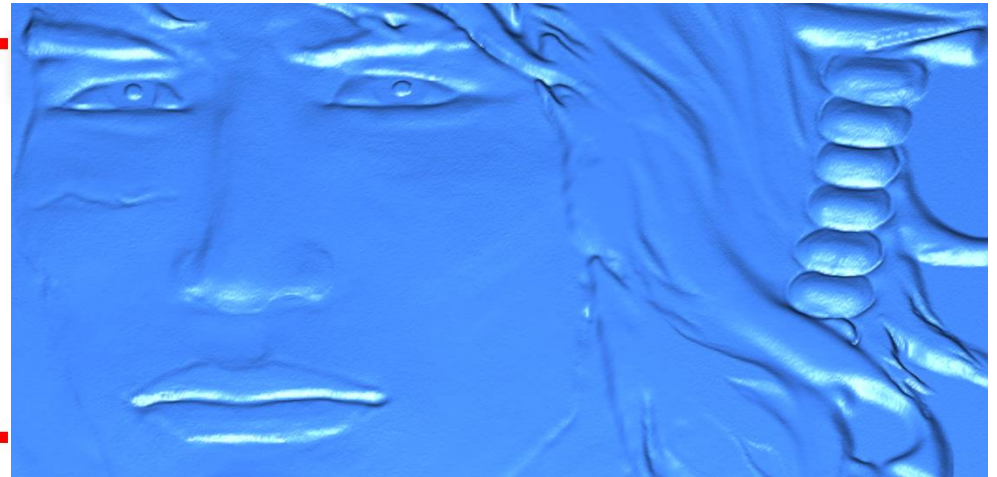

With smoothing

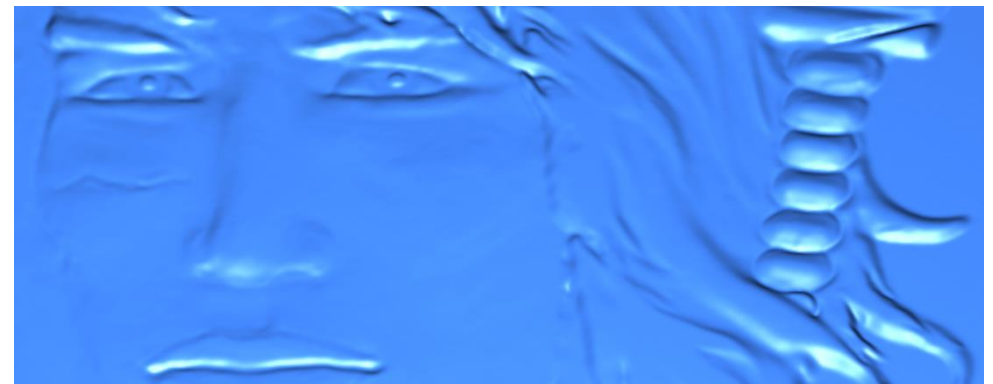

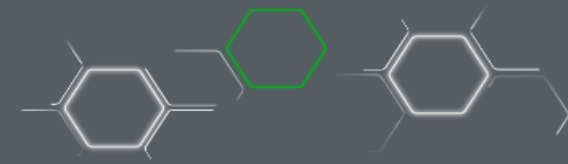

# TYPE CAM

As for the TYPE CAD and TYPE ART modules, the CAM module, TYPE CAM has been completely redesigned and simplified, in terms of interface, while maintaining efficiency.

Beyond the interface, our development team has also deeply modified the calculation algorithms to minimize the movements out of materials as well as the distance to be machined. Therefore, our toolpaths are becoming more and more smart, more optimized, more possibilities, more efficient. Let's take a detailed look at these new features.

## 1. INTERFACE REORGANIZATION

With the SVG icons, we also took the opportunity to completely reorganize the toolpath interfaces. They are cleaner, more efficient.

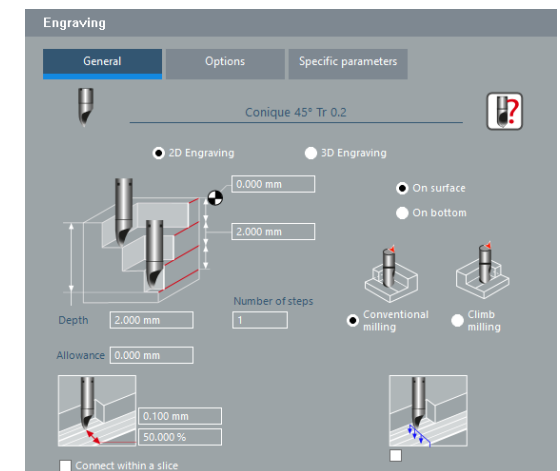
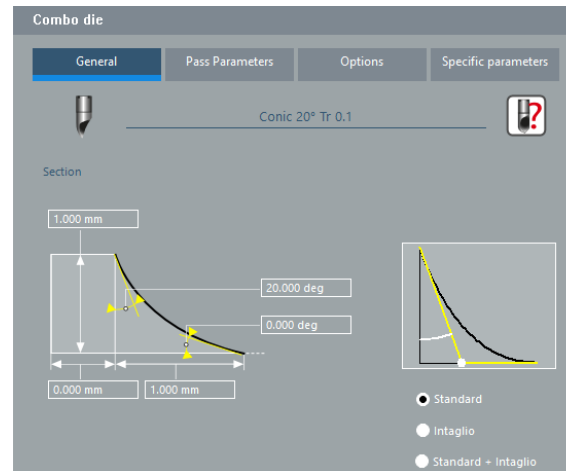
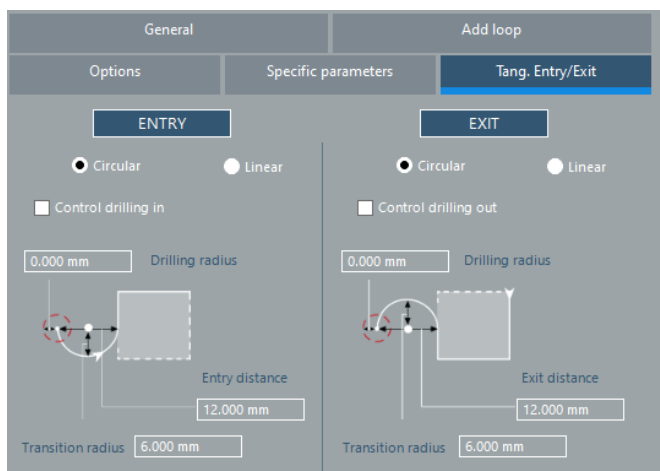
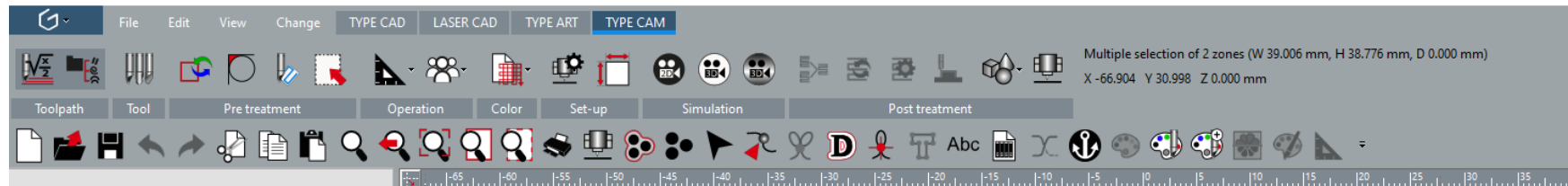

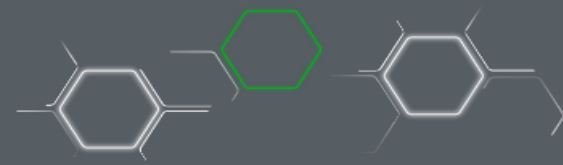

Example of a Prismatic Letter and Cutting toolpath interface.

### Prismatic letters

General Options Specific parameters

Conique 45° Tr 1.0

0.000 mm

2.000 mm

Depth 5.237 mm

Conventional milling

Climb milling

Compute !

Max. height 5.237 mm

Min. height 0.010 mm

Lateral steps

Accuracy 0.010 mm

### Cutting

Options Specific parameters Tang. Entry/Exit

General Add loop

End mill 3mm

2D Cutting

3D Cutting

0.000 mm

0.500 mm

Internal / External

Conventional milling

Climb milling

Number of steps 4

Depth 2.000 mm

Allowance 0.000 mm

Remove on last pass

Add bridges

1.000 mm

3.000 mm

100.000 mm

Tangential entry/exit

None

Manual

Rounded angle 0.000 mm

Added offset 0.000 mm

Fit for tool

Accuracy 0.010 mm

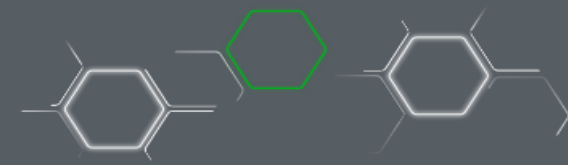

On the cutting toolpath, several interface and operation modifications have been made:

- Lead in / out :
  - There are only 2 options left: None and Manual. The Automatic option has been removed

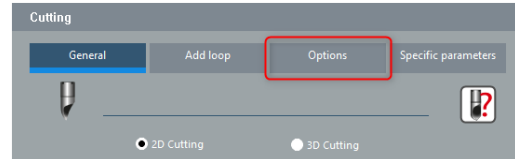
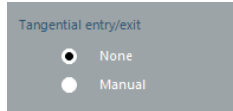

- In the " OPTIONS " tab
  - - All the parameters of the Lead in / out, which are used in the "Automatic" mode, present in previous versions, have been removed for a better use of these parameters.
  - - All parameters are now in the tab: Tangential Entry / Exit when the user decides to have them.

Versions prior to V14

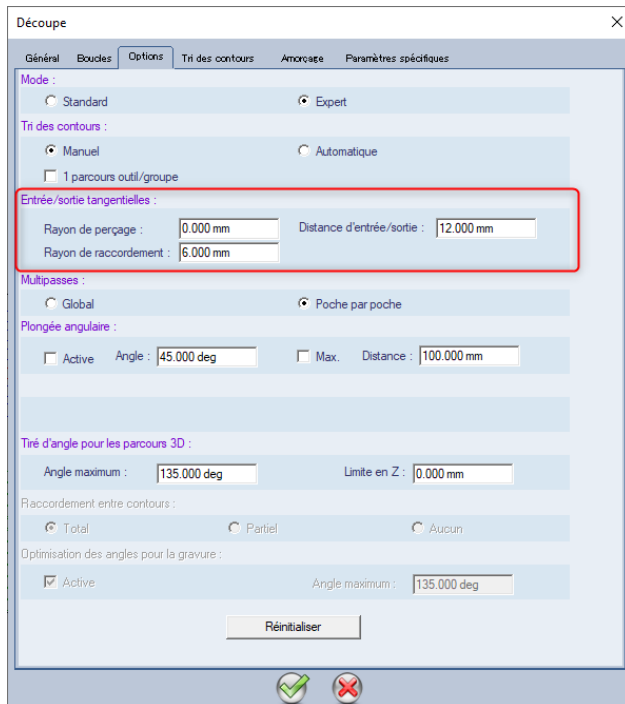

From Version V14 onwards

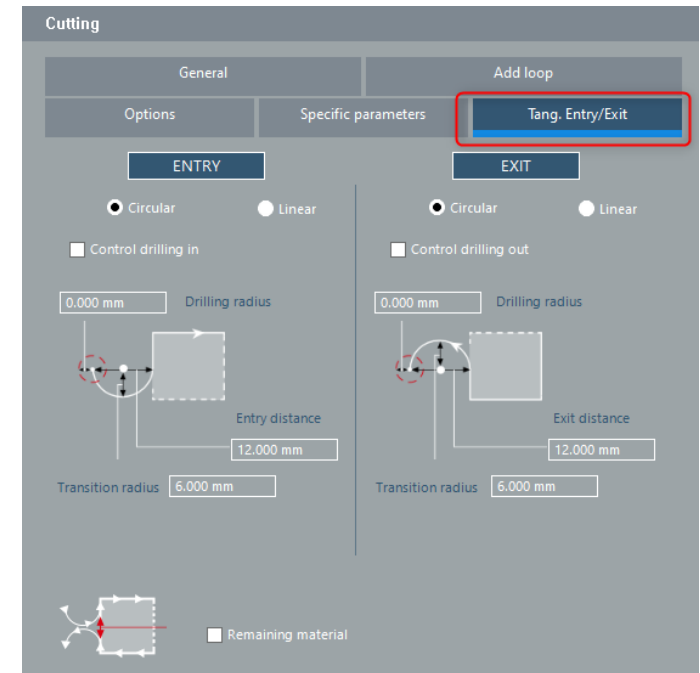
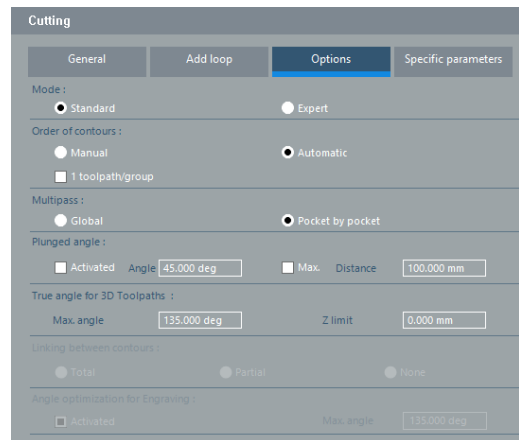

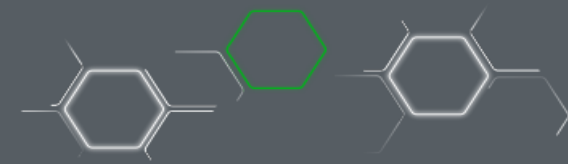

## 2. NEWS : OPTIMIZATION of the SWEEPING Toolpath

The goal of this optimization is to minimize the movements out of material, especially during the paths with several slices as well as the sweeping and angle breaking. It is a question of managing the connectivity between trajectories. With these new strategies, you will save a lot of time in your sweeping toolpaths.

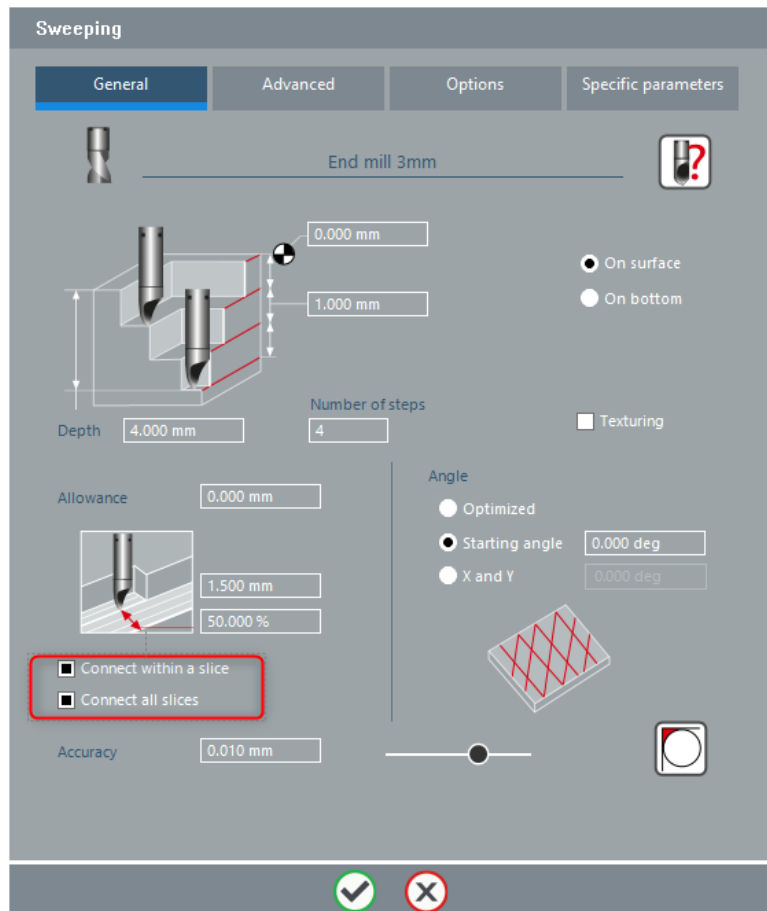

**2 new parameters** are now present in the interface that will allow to :

1. "Connect within the slice: connect sweeping and angle breaking.
2. "Connect all slices" connect all slices when they exist.

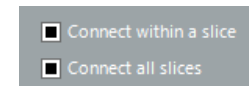

Example with ONE slice with and without the connectivity option

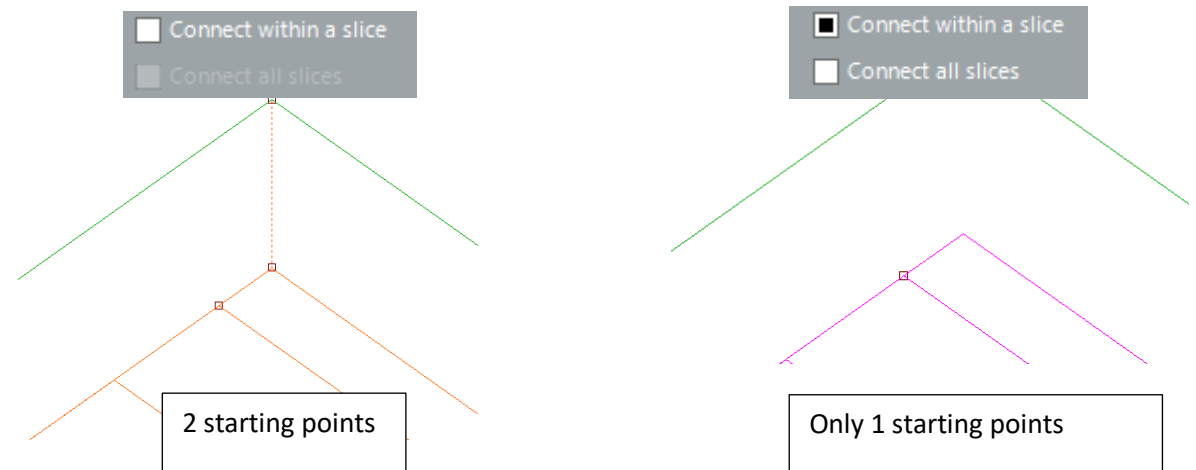

Note: if the connectivity option is checked then there will be "Sweeping" and "Corner Break", even if in the "Advanced" tab, the "Angle breaking" is not checked.

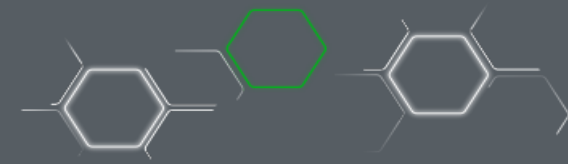

Without connection between slices

With connection between slices

Small square represent starting point

- Connect within a slice
- Connect all slices

- Connect within a slice
- Connect all slices

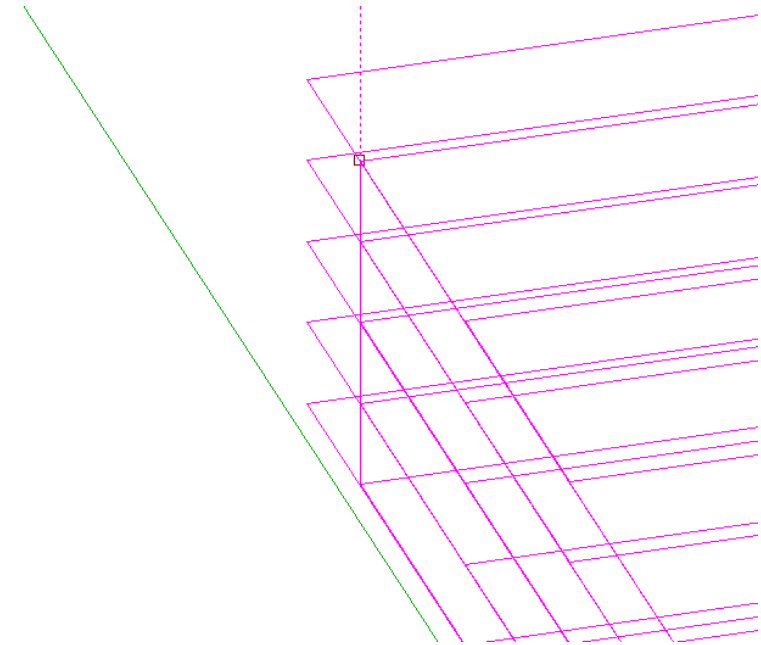
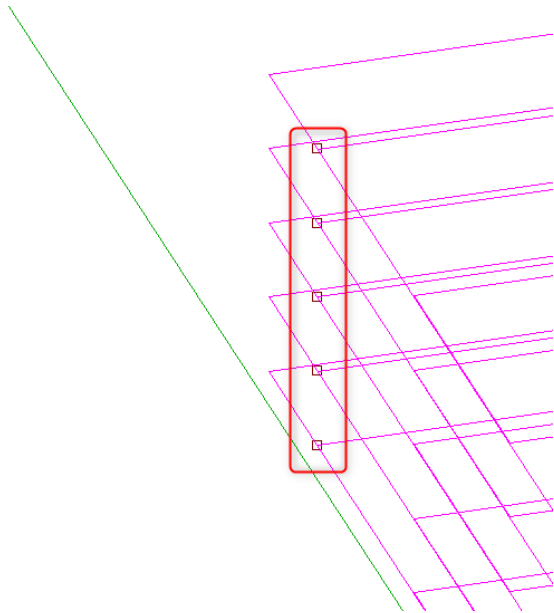

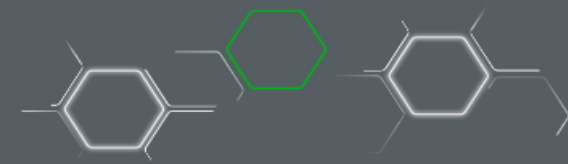

### 3. OPTIMIZATION of the ENGRAVING Toolpath

The engraving toolpath is probably the most used of all our toolpaths to remove material efficiently and obtain raised or recessed letters/logos. As for the sweeping toolpath, the goal of the optimization is to avoid unnecessary lifting and therefore plunging of the tool, which could damage or even break the tool.

**2 new parameters** are now present in the interface that will allow to manage the connectivity:

1. Connection between the 2D and 3D
2. Connection in multi slice

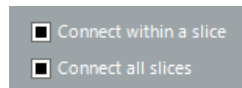

A single dive on a complex pocket with corner ascents

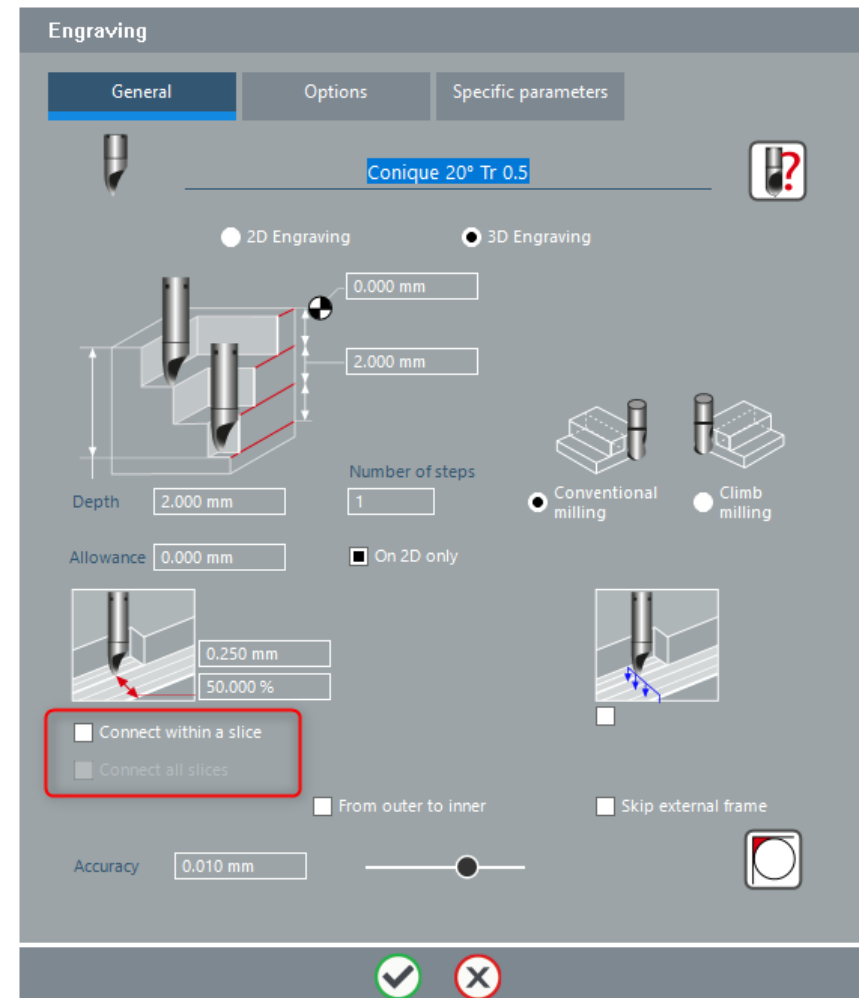
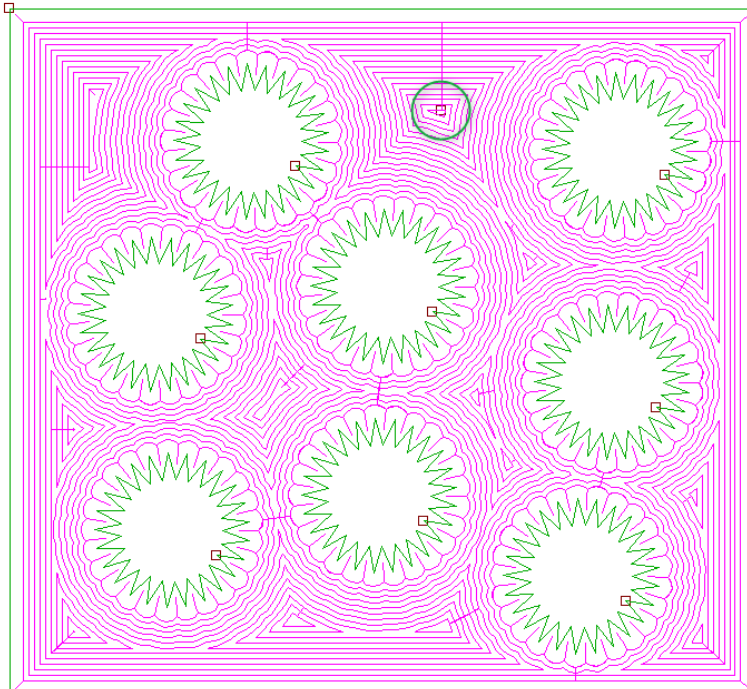

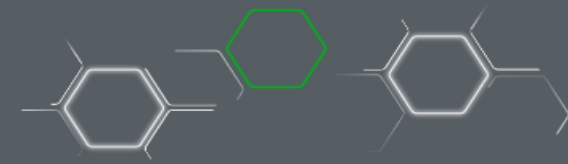

### A. Operation with « Connect within a slice »

**No connection** between 2D and 3D  
On a 25-pointed star : 26 plunges.  
No connection between 2D and 3D  
Distance out of material: **129 mm**

### With connection

On a 25-pointed star : **1 single plunge**  
Total connection between 2D and 3D  
Distance out of material: **0 mm**

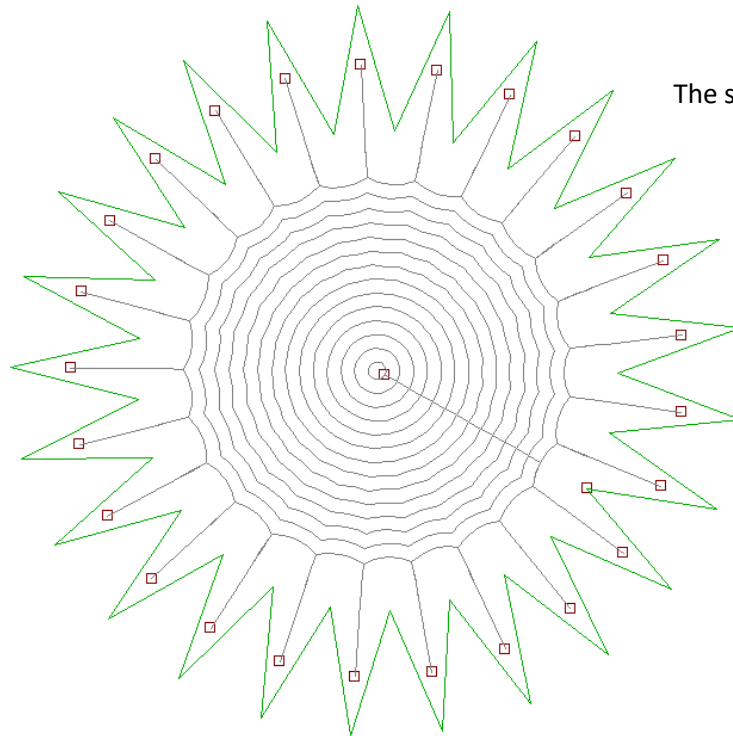
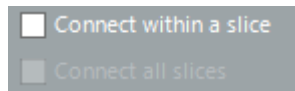

The small squares represent a starting point.

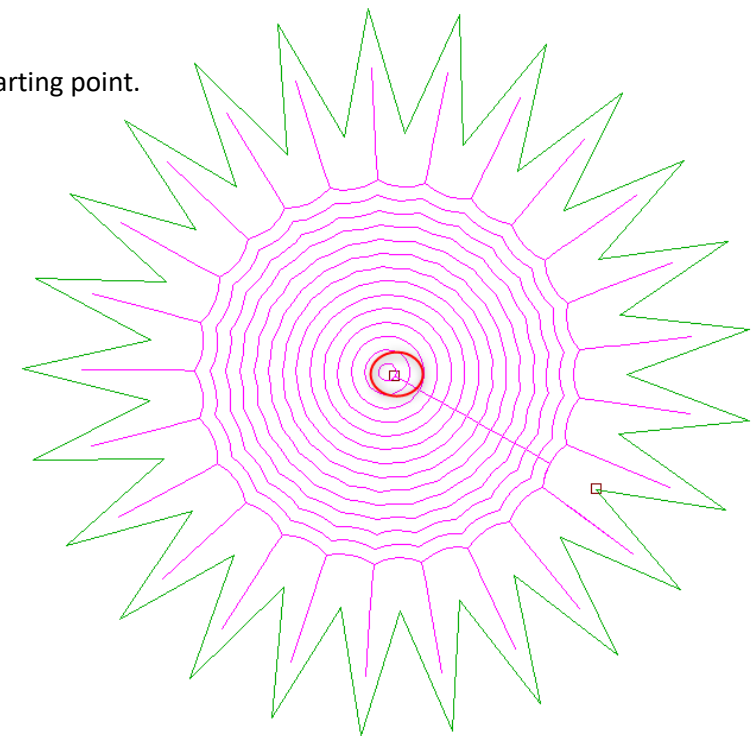
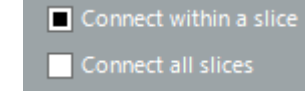



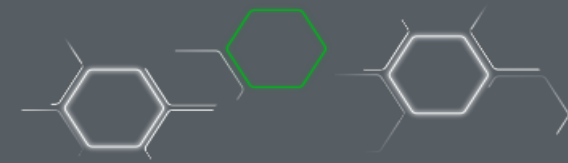

**B. Operation with the "Connect all slices" parameter. Example with 4 slices**

- Connect within a slice
- Connect all slices

Connection between 2D and 3D in one slice

**And 1 plunge per slice so 4 plunges in total.**

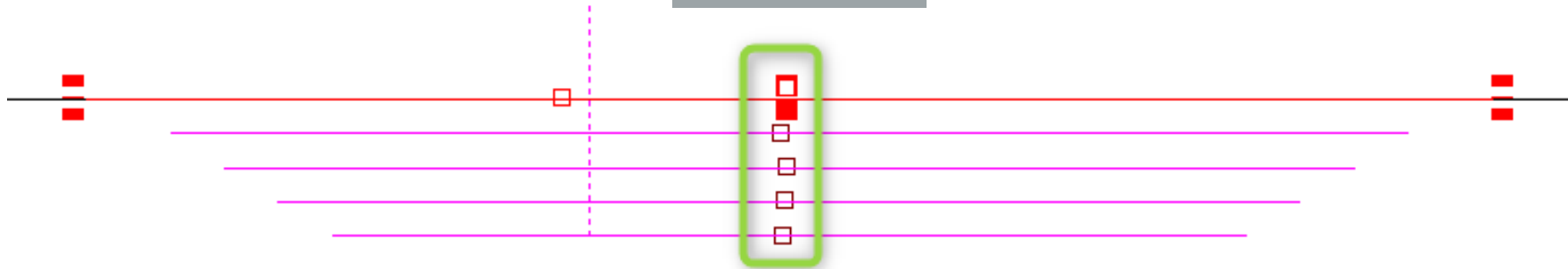

And connection all slices : **1 plunge in total for the 4 slices. The tool does not stand up for the whole run.**

- Connect within a slice
- Connect all slices

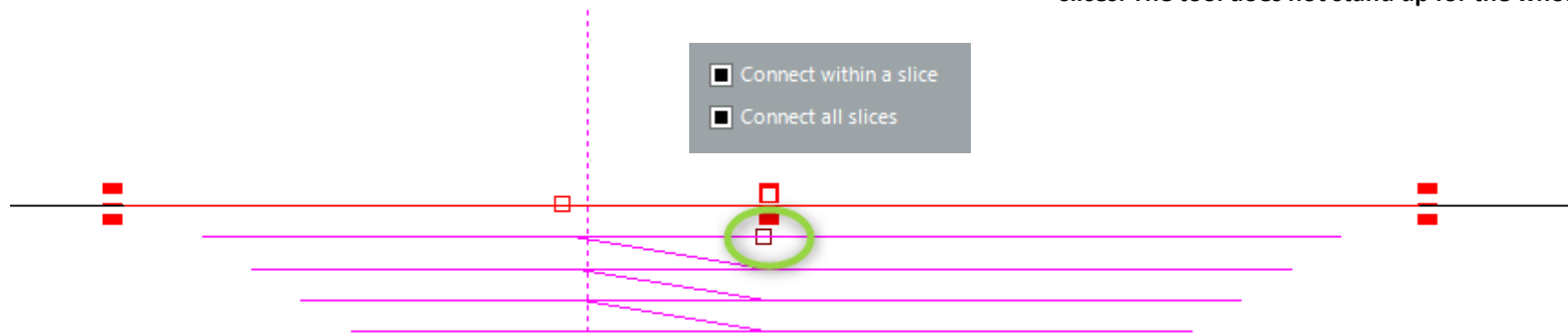

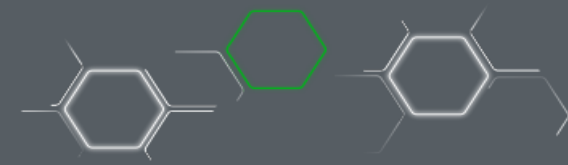

## 4. OPTIMIZATION of the SEQUENCE toolpath

The Sequence toolpath is central to our desire to offer our engraver customers the best solution on the market to optimize the removal of material efficiently and to obtain raised or recessed letters/logos with several tools. The challenge of this development is threefold: to offer more functionalities for each tool, to minimize the movement out of material and finally to machine only the right amount of material for each tool. A great challenge for our development team.

### A. New interface

**Sequence**

General Options Specific parameters

Cylindrique Ø 6.0 mm  
Conique 20° Tr 1.0  
Conique 20° Tr 0.2

On surface  
 On bottom

Allowance

Skip external frame

Accuracy

Depth

Change depth

Connect within a slice

Connect all slices

Sweeping

Contouring

2D Engraving

Number of steps

Conventional milling

Climb milling

2D Engraving

3D Engraving

Depth

Number of steps

Change depth

Connect within a slice

Connect all slices

Sweeping

Contouring

Angle

Optimized

Starting angle

X and Y

**Sequence toolpath**

Cylindrique Ø 6.0 mm

Depth

Number of steps

Change depth

Connect within a slice

Connect all slices

Sweeping

Contouring

2D Engraving

Depth

Number of steps

Change depth

Connect within a slice

Connect all slices

Sweeping

Contouring

Conventional milling

Climb milling

2D Engraving

3D Engraving

Depth

Number of steps

Change depth

Connect within a slice

Connect all slices

Sweeping

Contouring

Angle

Optimized

Starting angle

X and Y

**Sequence toolpath**

Conique 20° Tr 1.0

Depth

Number of steps

Change depth

Connect within a slice

Connect all slices

Sweeping

Contouring

2D Engraving

3D Engraving

Depth

Number of steps

Change depth

Connect within a slice

Connect all slices

Sweeping

Contouring

Angle

Optimized

Starting angle

X and Y

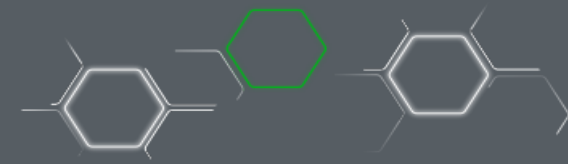

## B. New Feature: Sweeping Available for ALL Tools in 2D and 3D

In previous versions, the sweeping option was only available for the first tool. The following tools had to be in Engraving. With the new V14 version, the Sweeping option can be selected for any tool in the list.

In our example, the first toolpath is in Engraving and the last 2 tools are in Sweeping mode at 90 and 0°.

Zoom on an area with the 3 tools and associated strategies in 2D.

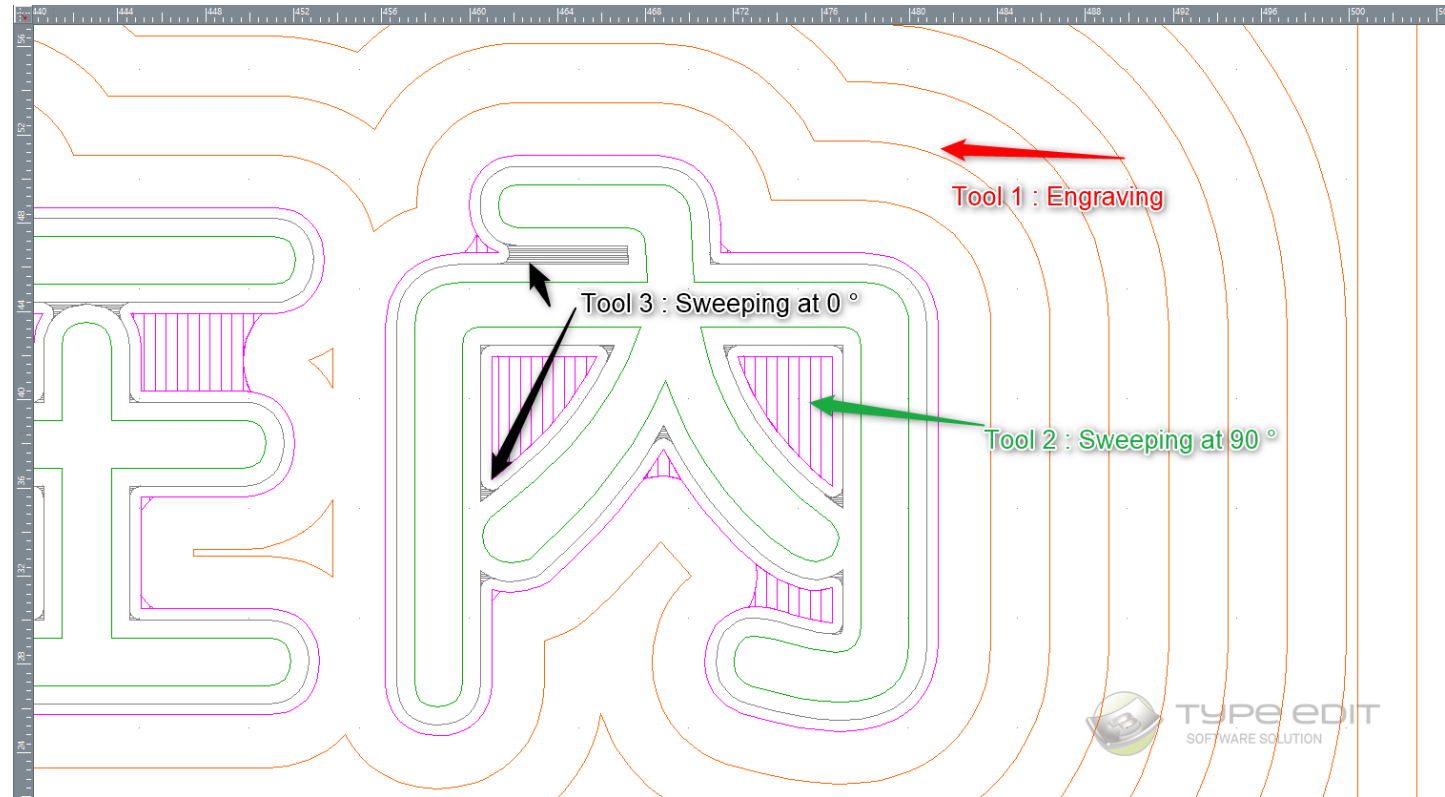
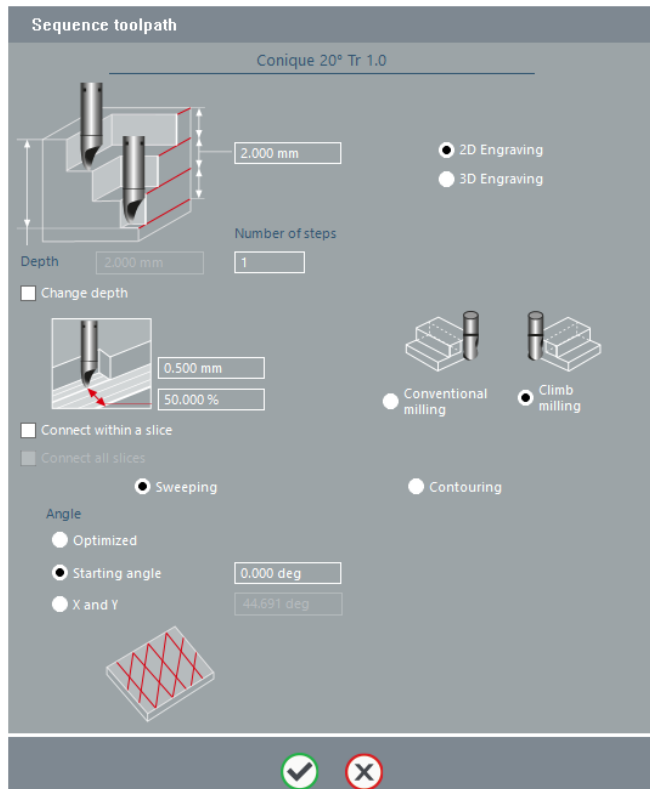

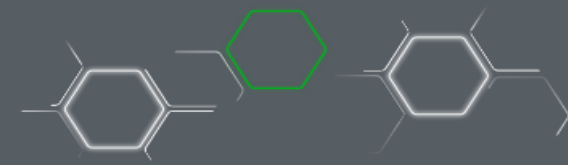

### C. Connectivity to minimize out of material movement

As in sweeping and engraving, each tool in the range manages connectivity. Our algorithm therefore introduces 2 new parameters :

- Connectivity within a slice
- And the connectivity between all the slice

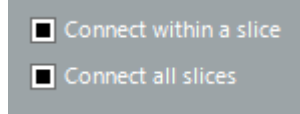

**Connect within a slice** will connect, in each pocket, when possible, all 2D parts with its 3D finish. The goal is to avoid lifting the tools and therefore making plunges that risk damaging the tools, especially in hard materials like metal.

**Connect all the slices** will connect, in each pocket, when possible, all the slices together. The goal is to avoid lifting the tools between slices and thus preserve the life of the tool.

Example of connectivity in a pass and the gain in number of plunges with our courses under V14

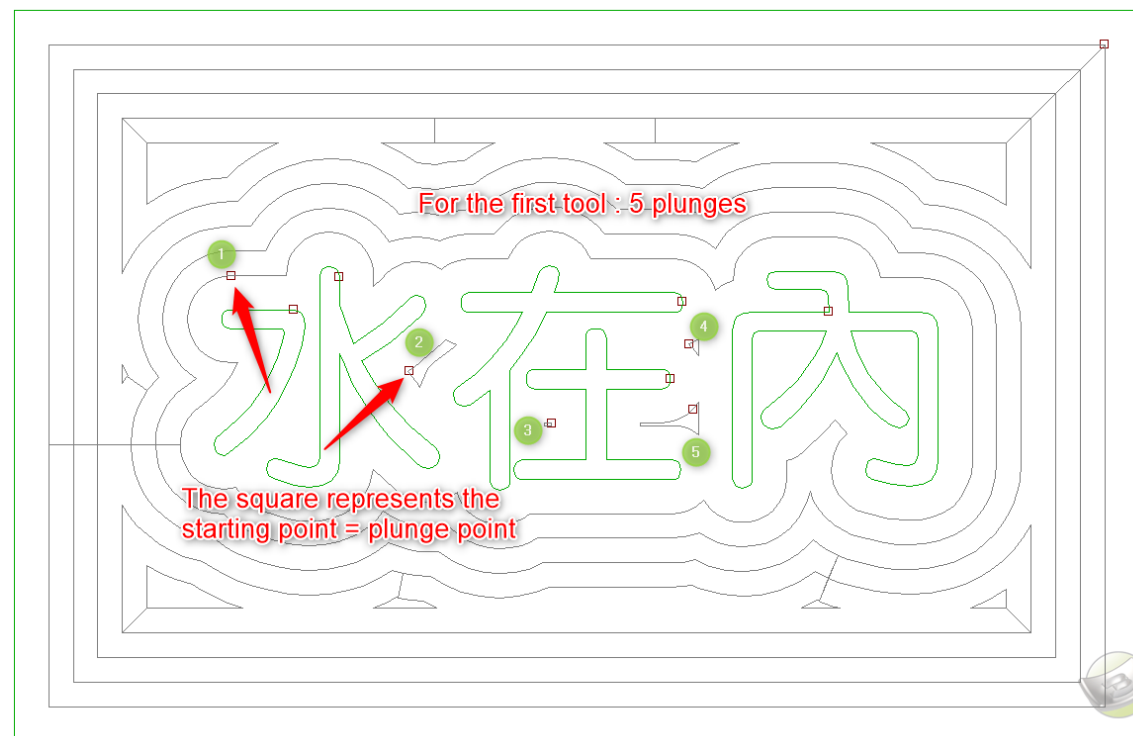

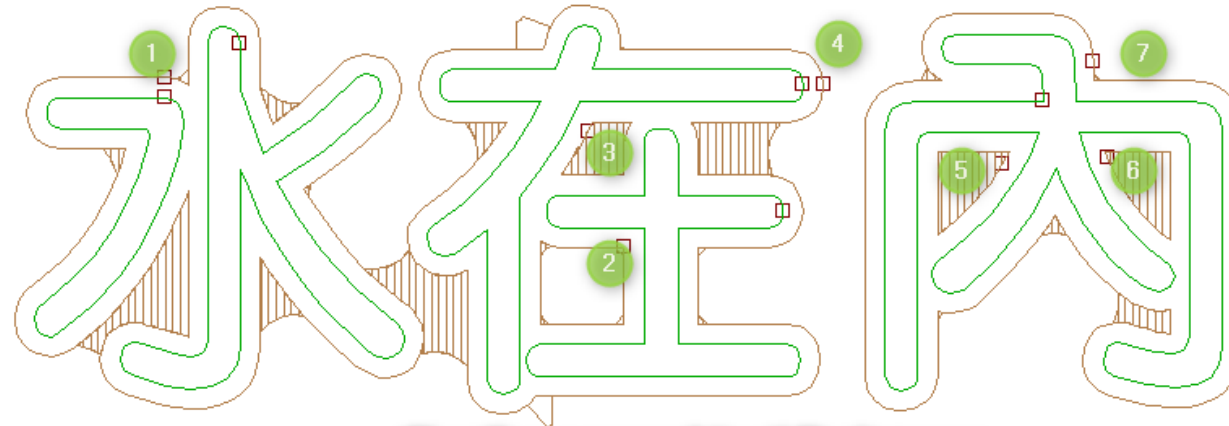
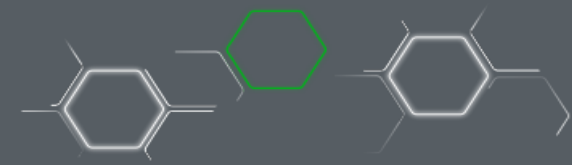

For the second tool 7 plunges

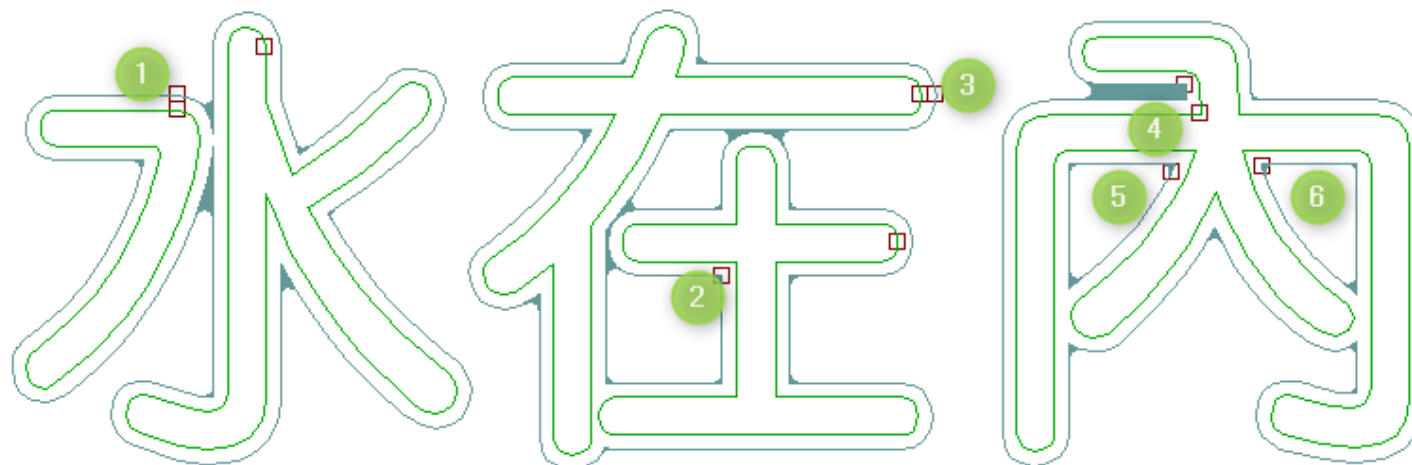

Last tool : 6 plunges only



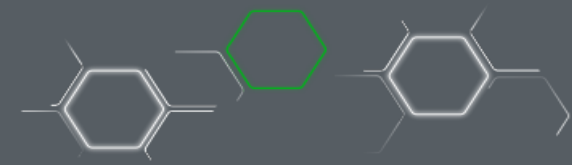

For the first tool, same number of plunges as for one single slice. So, we save 100 % of plunges for this tool from previous version.

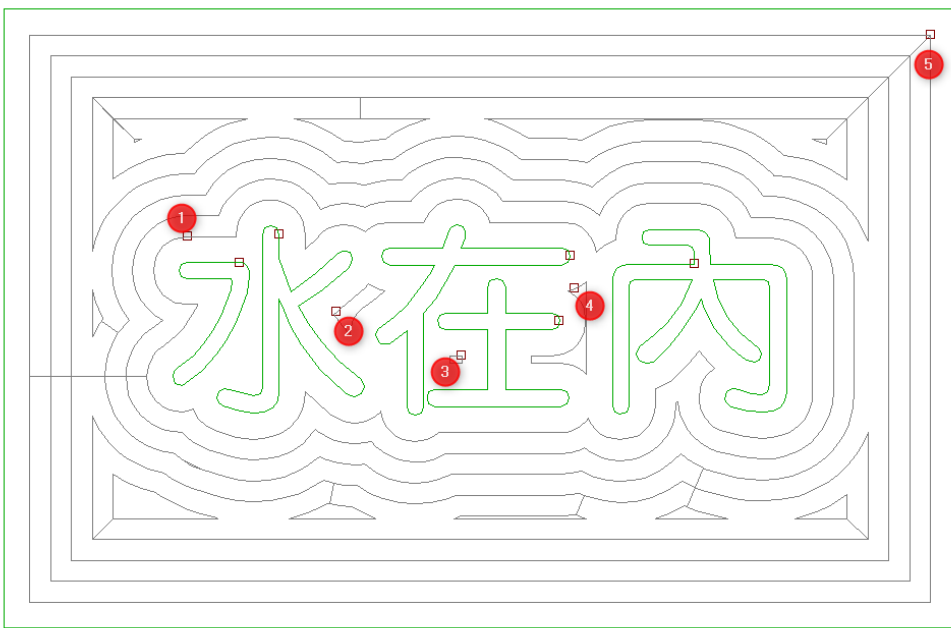

The connection between slice in detail.

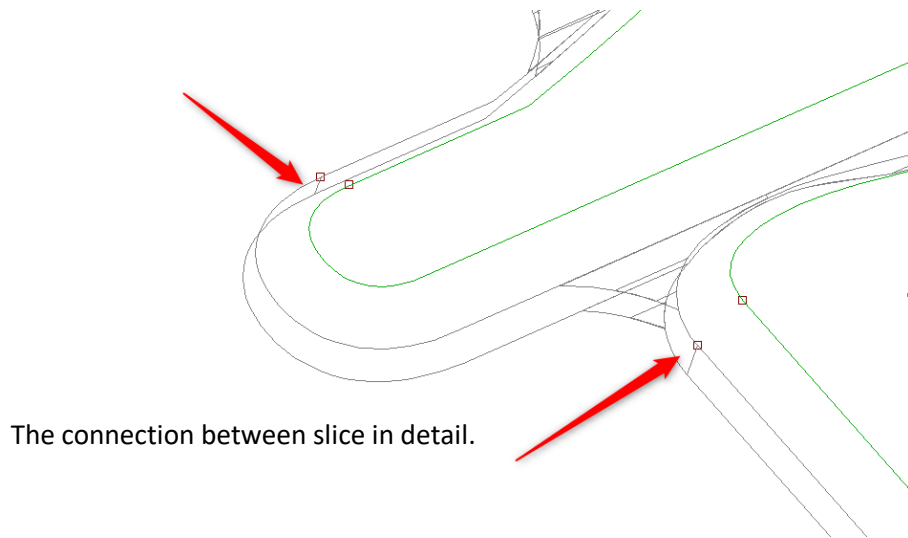
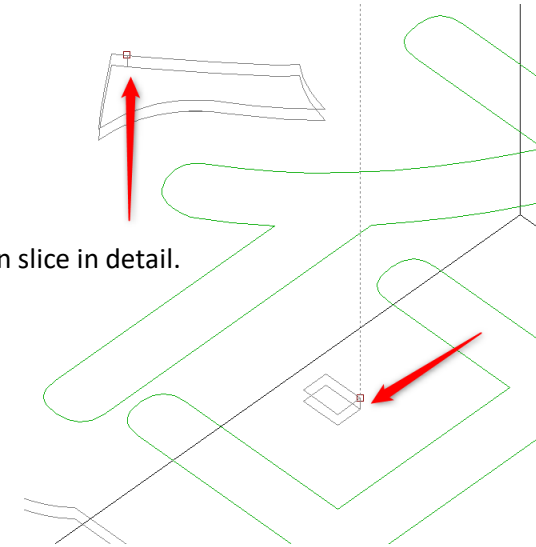

The connection between slice in detail.

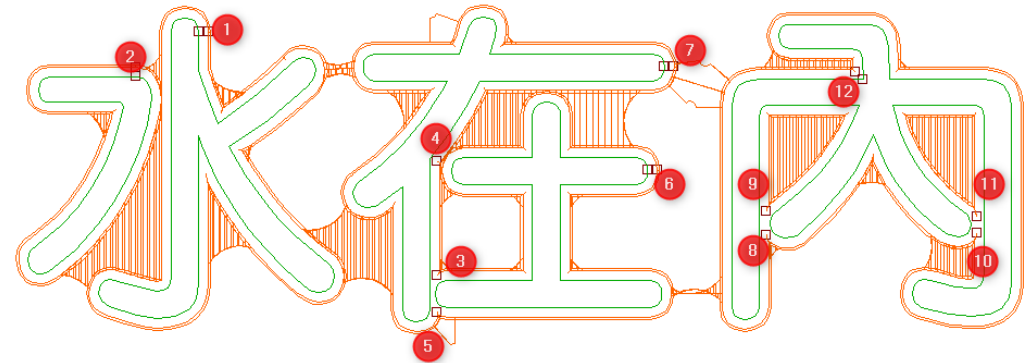

For the second tool, only 12 plunges for 2 D and 3D with 2 slices.

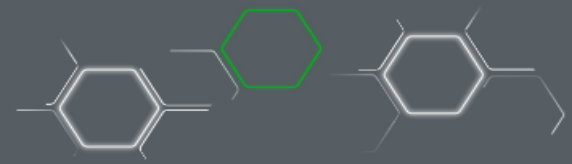

For the last tool, only 5 plunges for 2 D and 3D with 2 slices.

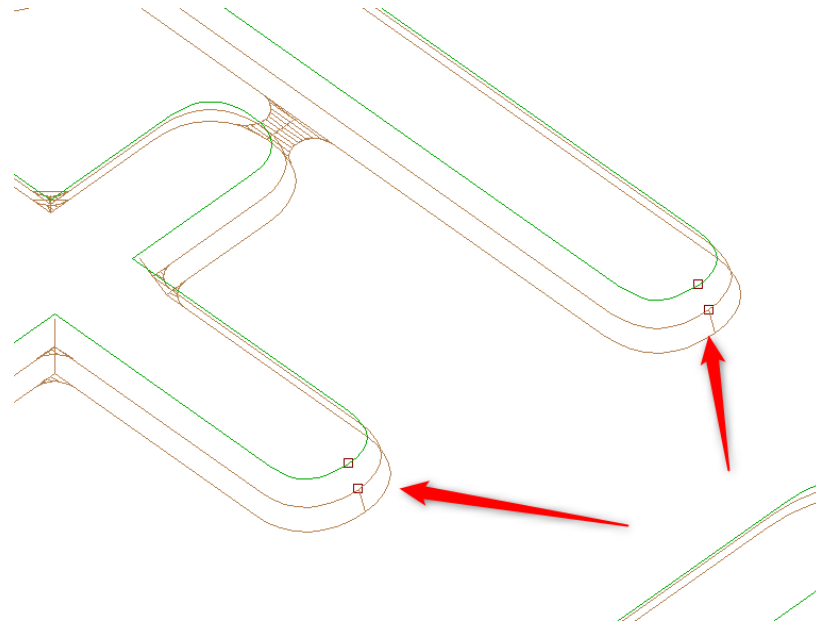
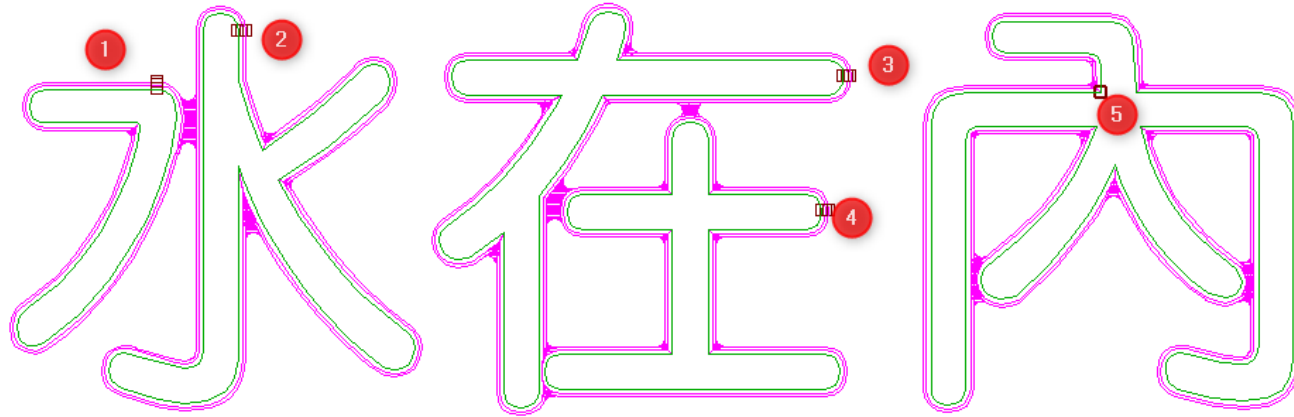

The connection between slice in detail.



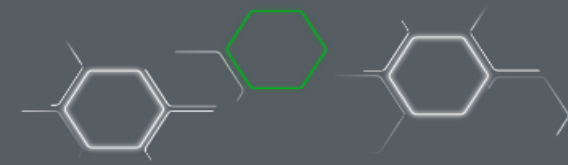

## D. Tool-optimized zone machining

In this version, particular attention has been paid to ensure that the paths of each tool are truly optimized. To make it simple, each tool, according to its parameters, will remove the material to the maximum of its possibilities. The paths will not, for example, unnecessarily machine in the air.

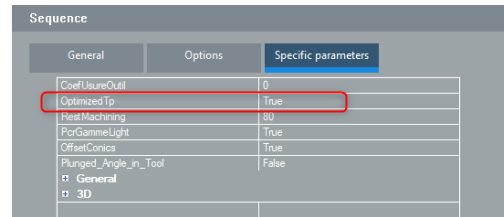
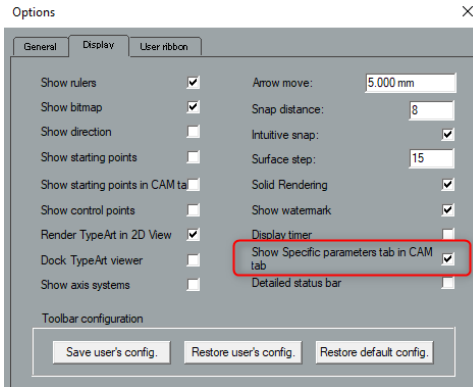

To activate the optimization of zone machining, the **"Specific parameters"** must be displayed in the **"Options"**.

In the Sequence path, the **"OptimizedTp"** parameter must be set to **"True"**.

Let us take a simple case to visualize how it works, in 2D.

- ❶ : Bigger tool N° 1
- ❷ : medium tool N° 2
- ❸ : finishing tool N° 3

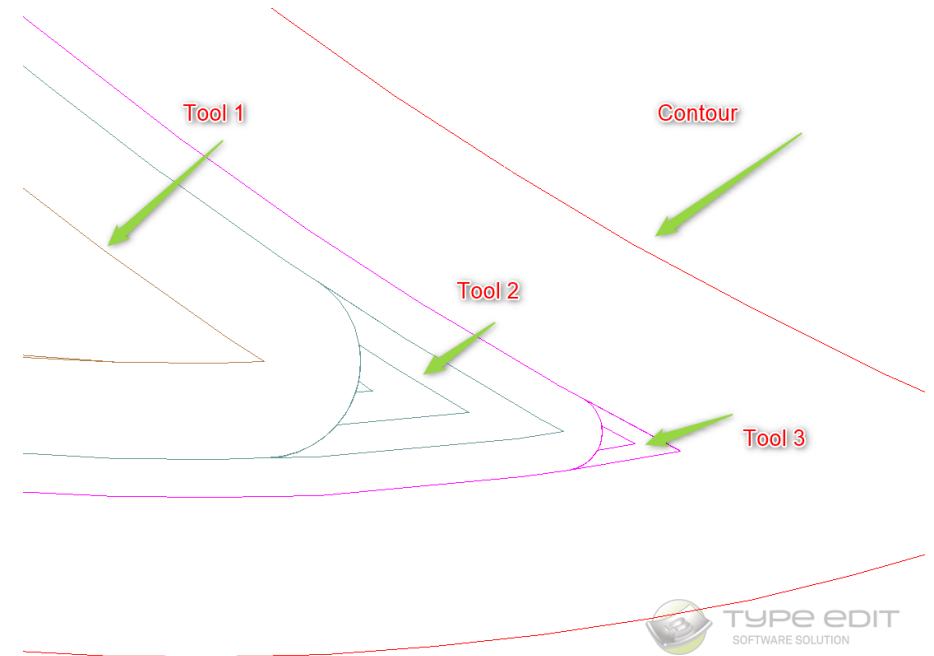
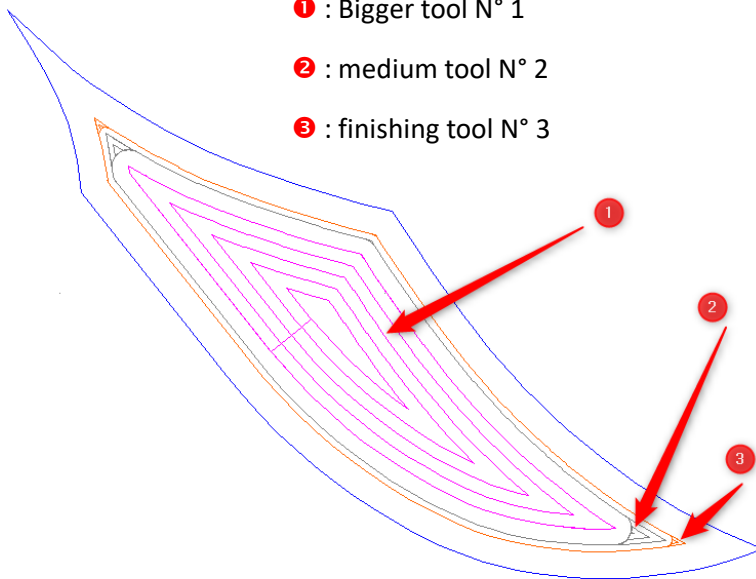

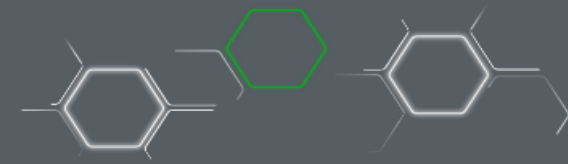

Details of the tool positions in the corners. We clearly see a perfect overlap between the previous and the next tool.

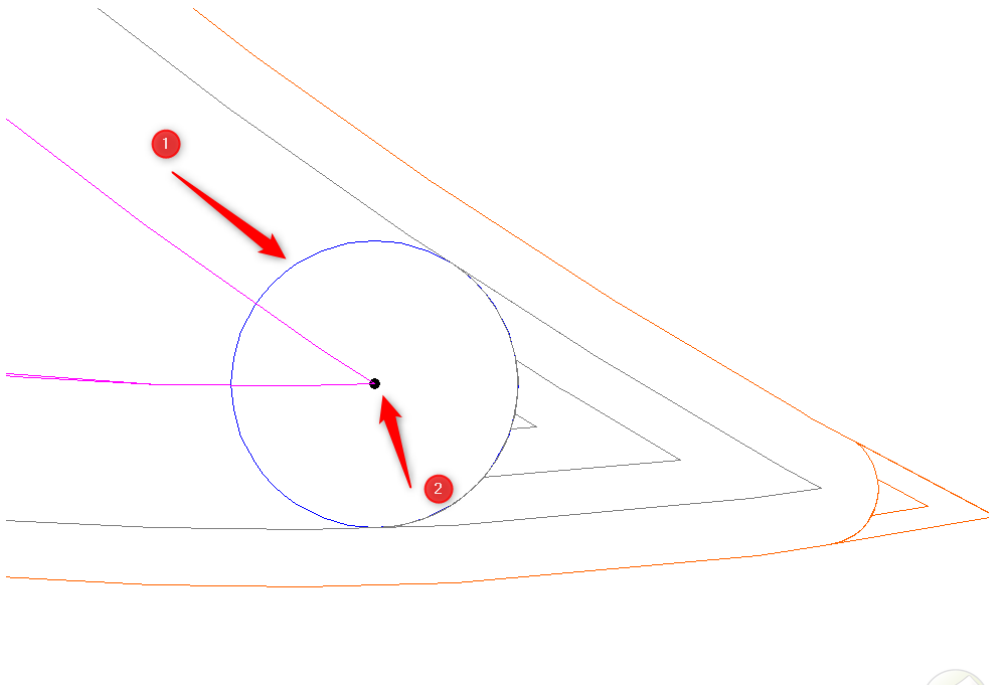

The diameter (1) of the first tool fit the toolpath of the second one.  
The step over is optimum.

2 : is the center of the first tool.

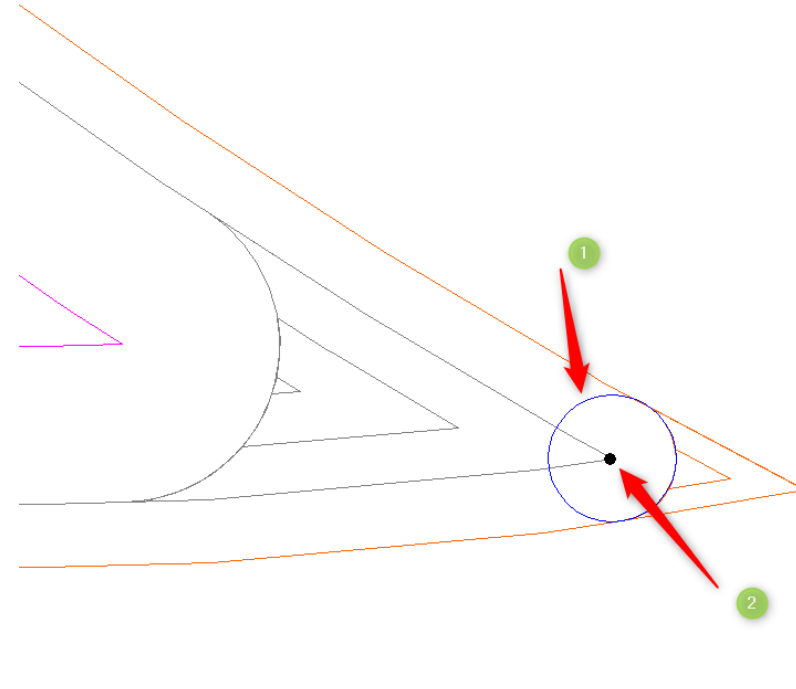

The diameter (1) of the second tool fit the toolpath of the finishing one. The step over is optimum.

2 : is the center of the second tool.

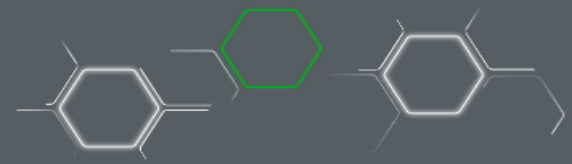

Details with the 3D  option in the corners

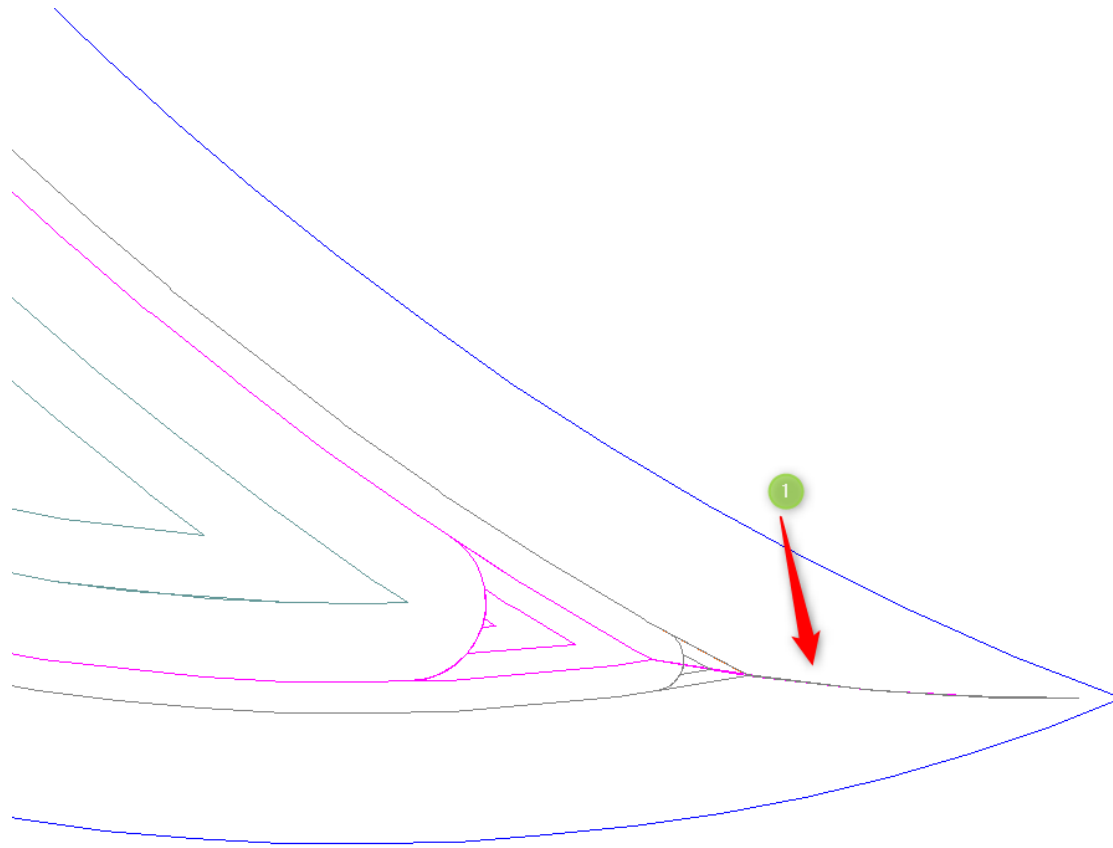

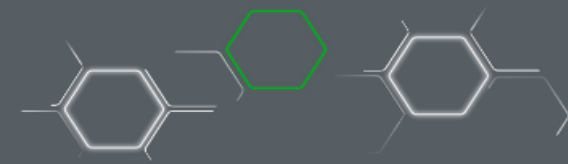

## 5. NEW: COLOR FOR CAM

The Approach to Color for CAM is totally and completely renewed. It will allow greater ease of use and access to all the possibilities of CAM. As soon as the function is launched, the Environment changes and a resizable "Parameters" window opens :

The "Settings" window

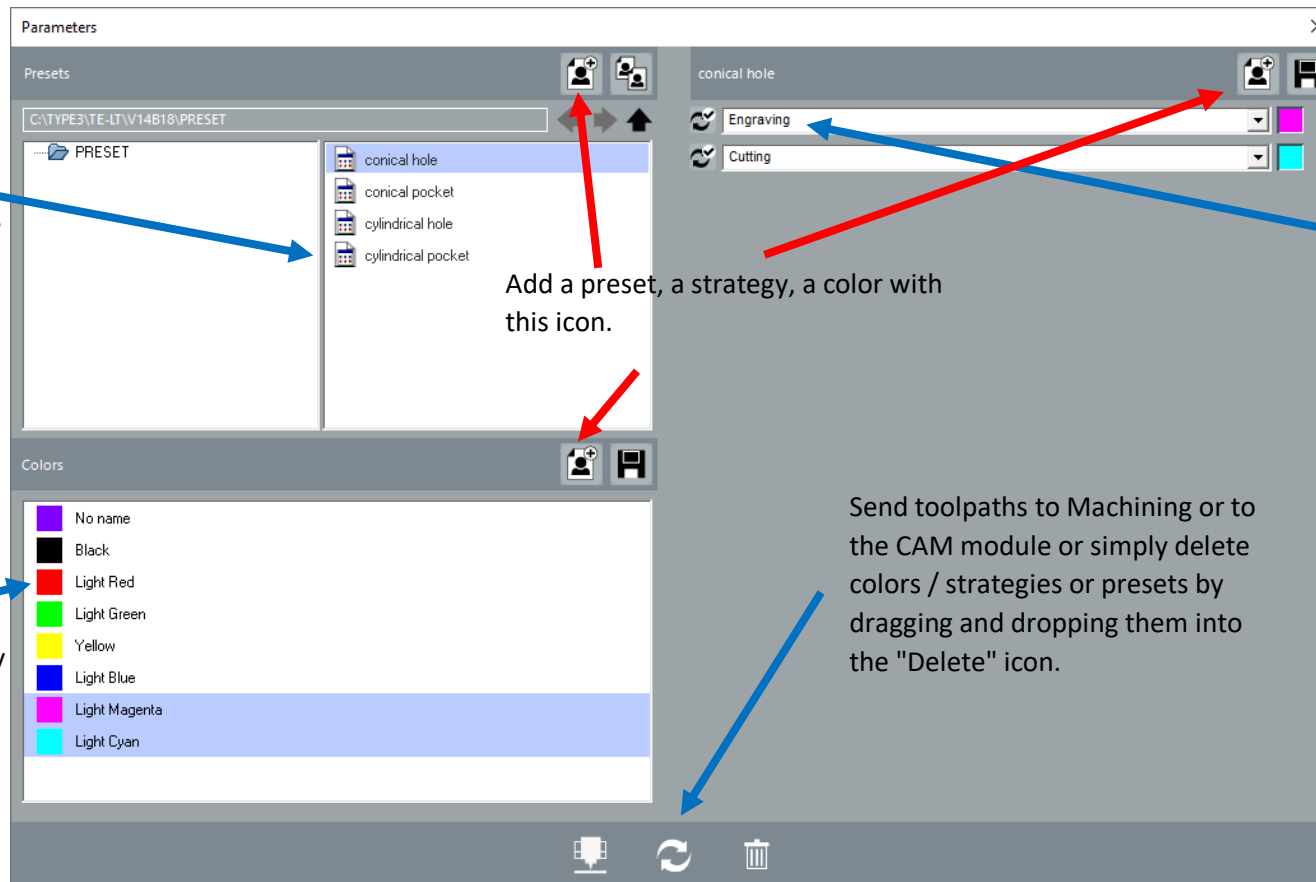

The list of presets is always visible and available. Simply organize your presets. You can add / delete and save them.

The color list has been simplified but you can still add your own color codes and save them. Changing the name or position is of course possible.

Finally, the software automatically detects the colors contained in your selection.

Add a preset, a strategy, a color with this icon.

Send toolpaths to Machining or to the CAM module or simply delete colors / strategies or presets by dragging and dropping them into the "Delete" icon.

For each color in the selection, you can associate a machining strategy. And decide for each strategy whether the calculation will be used.

You can also organize the machining order by moving each strategy wherever you want.

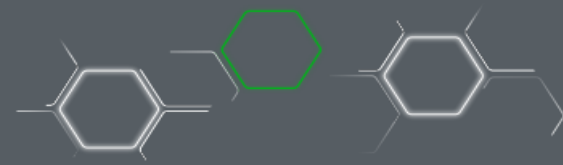

## The complete environment

The screenshot displays the Type Edit software interface. At the top, there is a menu bar with options like File, Edit, View, Change, Smart toolpath, TYPE CAD, LASER CAD, TYPE ART, TYPE CAM, and Specific functions. Below the menu is a toolbar with various icons for toolpath generation and simulation. The main workspace shows a CAD model with toolpaths overlaid in different colors (red, green, blue, purple).

Overlaid on the workspace are several windows:

- Toolpath list:** A tree view showing the hierarchy of toolpaths, including '19mm Caisson 1', '19mm Caisson 2', '19mm Caisson 3', and '9mm Caisson 1', '9mm Caisson 2', '9mm Caisson 3'. Each caisson contains an 'ELEMENT CUISINE 19 MM' with sub-elements like 'Gravure', 'Découpe', and 'Perçage'.
- Parameters:** A window showing the configuration for the selected toolpath. It includes a 'Presets' section with a file path and a list of toolpaths. A blue arrow points to a dropdown arrow in the 'Découpe' section.
- Colors:** A window showing a list of colors used for toolpaths, such as 'No name', 'Light Red', 'Light Blue', 'Black', 'Light Green', 'Yellow', and 'Light Magenta'.
- Engraving List:** A dropdown menu showing options like 'Engraving', 'Plotting', 'Vinyl', 'Drilling', '2D Cutting', and '2D Engraving'. A red arrow points to the 'Engraving' option.

By clicking on the arrow, ALL the toolpaths available in your configuration are displayed.

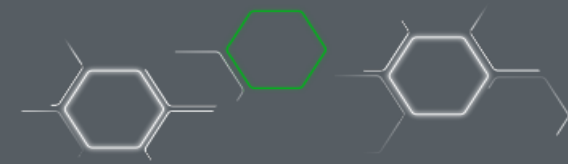

Here is the description of this environment which will allow you to prepare your machining process.

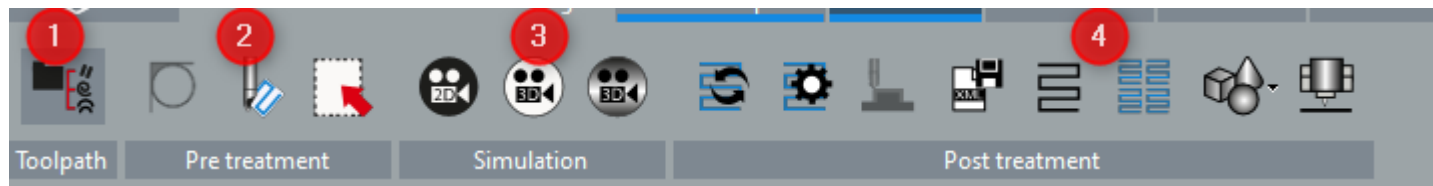

1. List of toolpaths
2. Pre-treatment
3. Simulation
4. Post-treatment

### 1. 1. List of toolpaths

Once you have started the calculation in the CAM module, the list of toolpaths is displayed in the planes where the curves are located.

You can manage the toolpath list (by renaming, deleting, etc.) as in the CAM module.

The color to the right of each toolpath indicates the color of the contour.

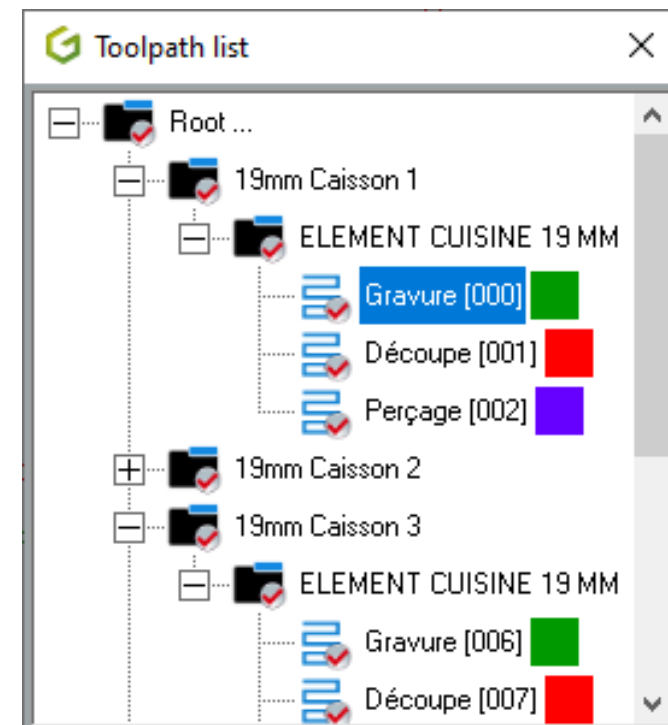

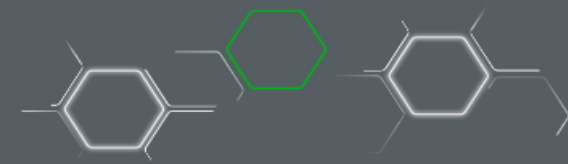

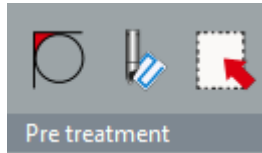

## 2. Pre-treatment



3 actions are possible:

- See the areas where the selected tool cannot pass, 
- Simulate with a given tool with a depth, 
- Selection and sorting of contours to optimize your toolpaths 

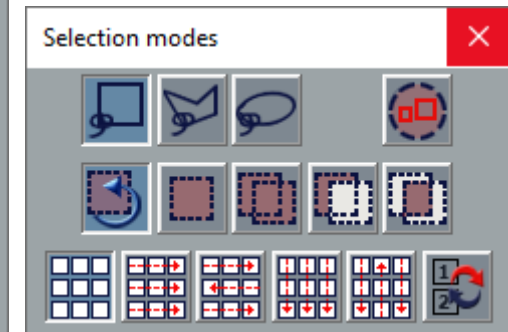
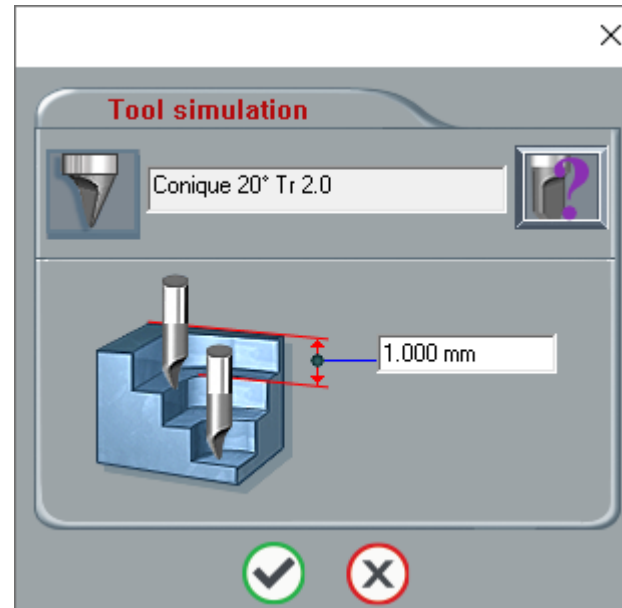
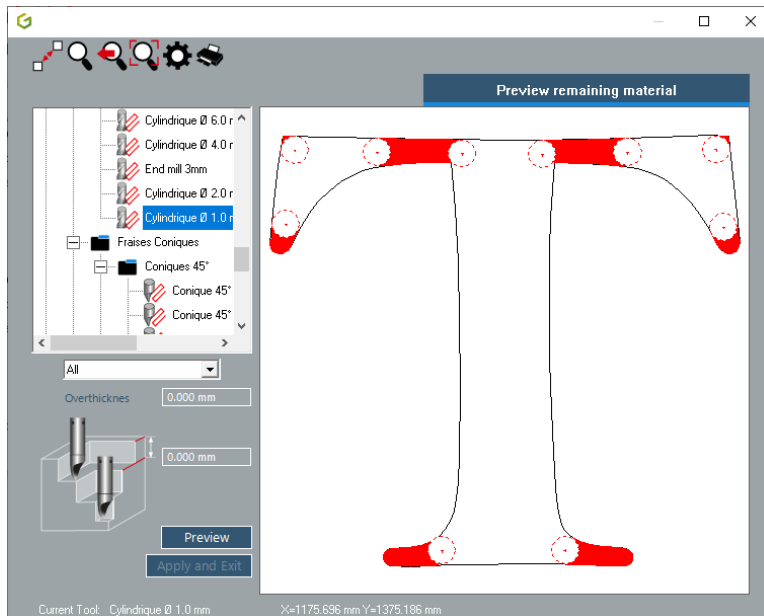

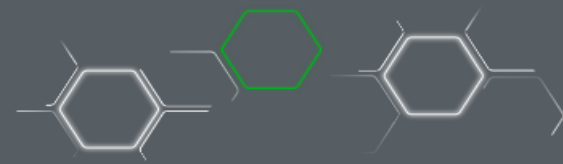

### 3. Simulation 2D and 3D

Select your toolpaths to simulate then simply choose a 2D or 3-D simulation.



Simulation 2D 

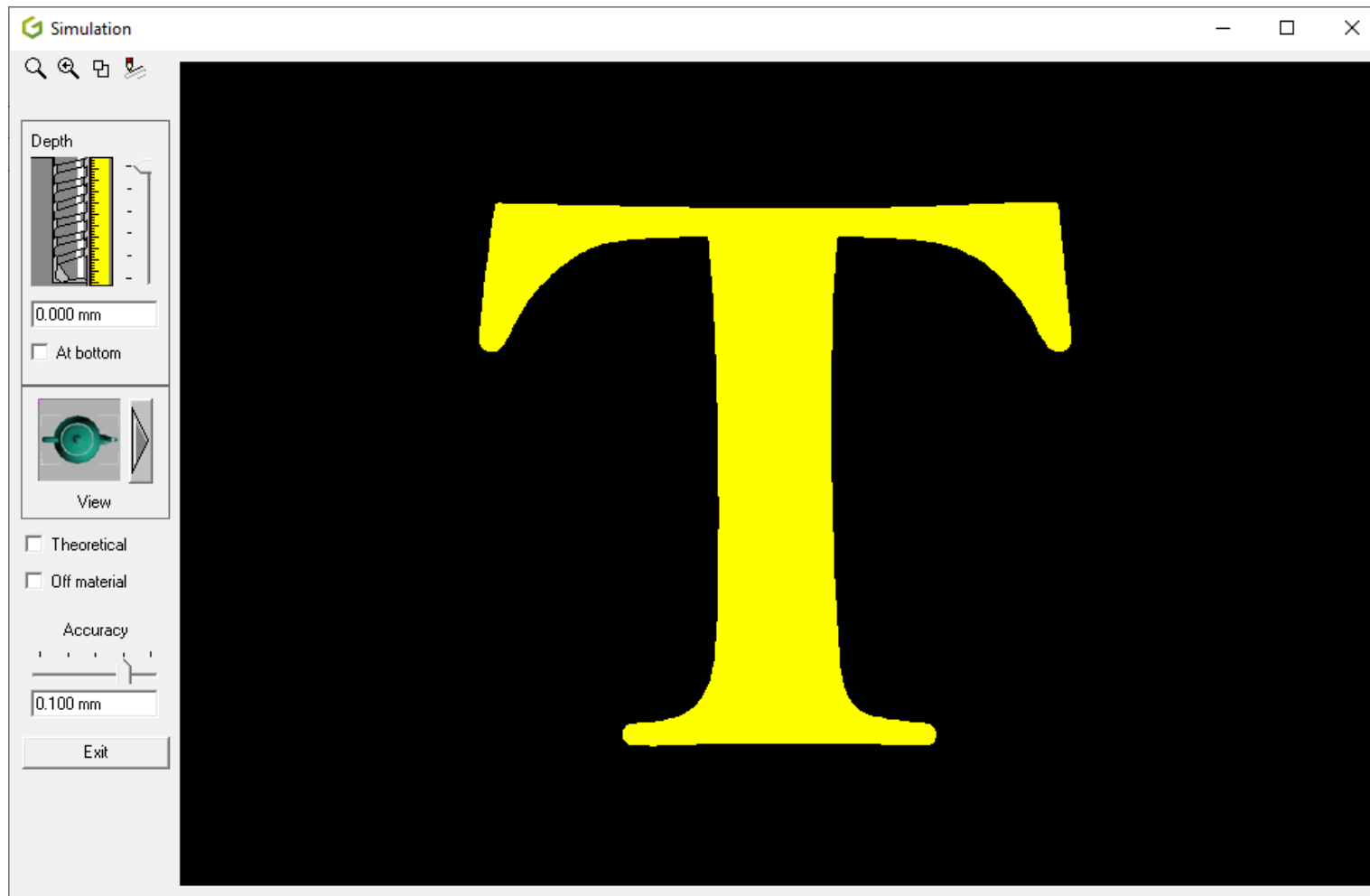



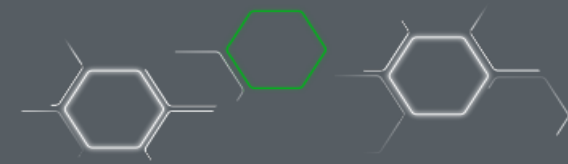

**Precise 3D simulation**, you will get details you will have with the real tools on your machine. You can zoom out / in in any area.

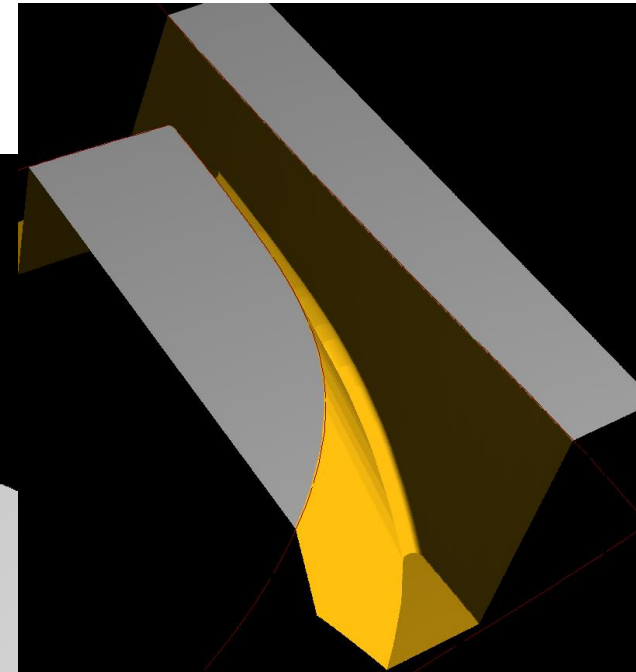
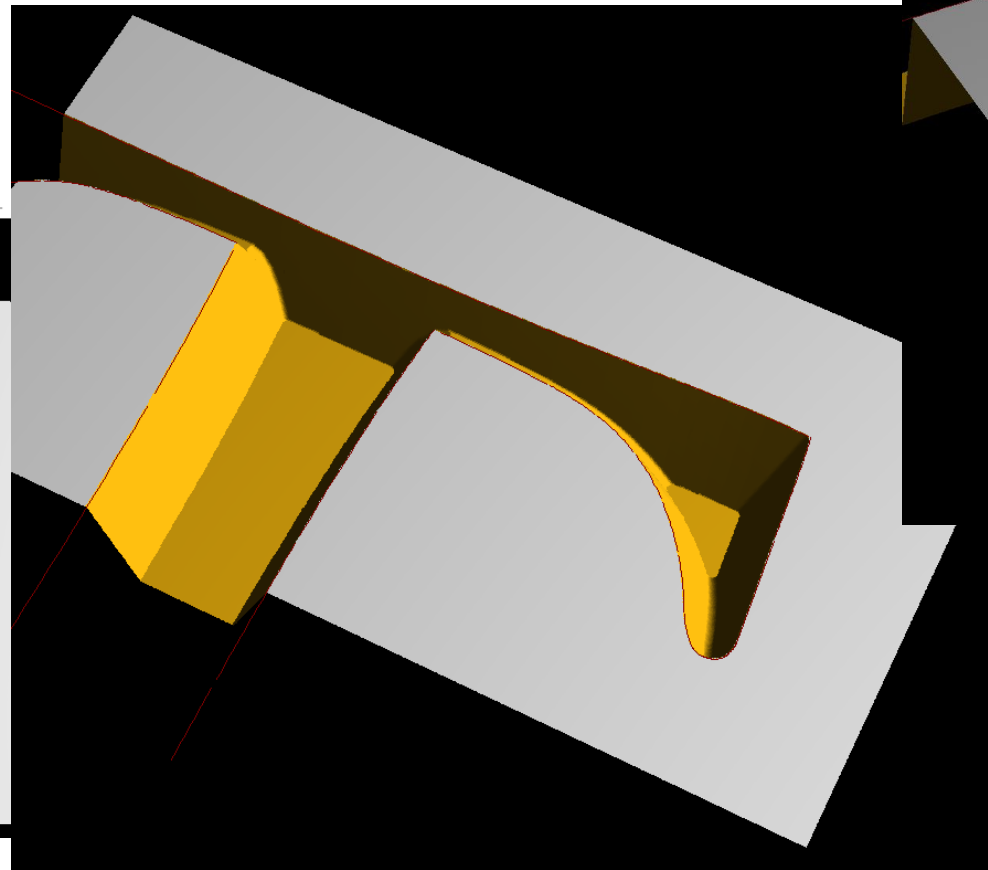
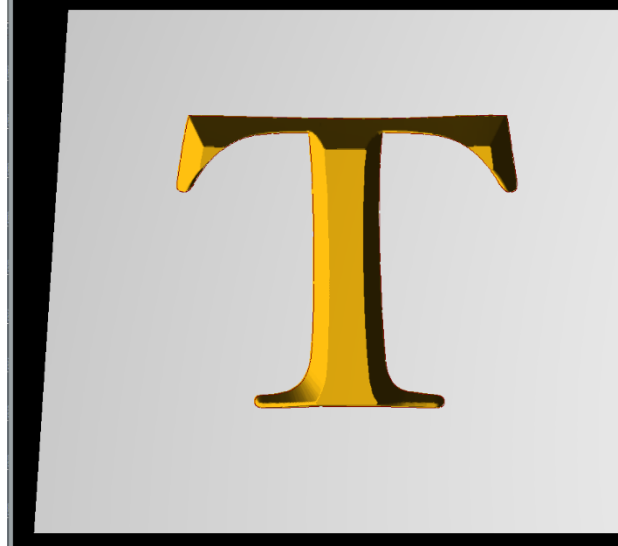
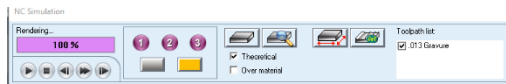

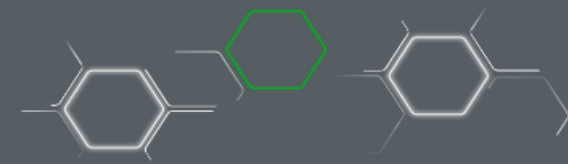

**Dynamic 3D simulation**, with the possibility to load materials such as wood or metal. Thanks to the commands, go step by step to make sure that the machining is correct or go back, speed up or pause. Anything is possible

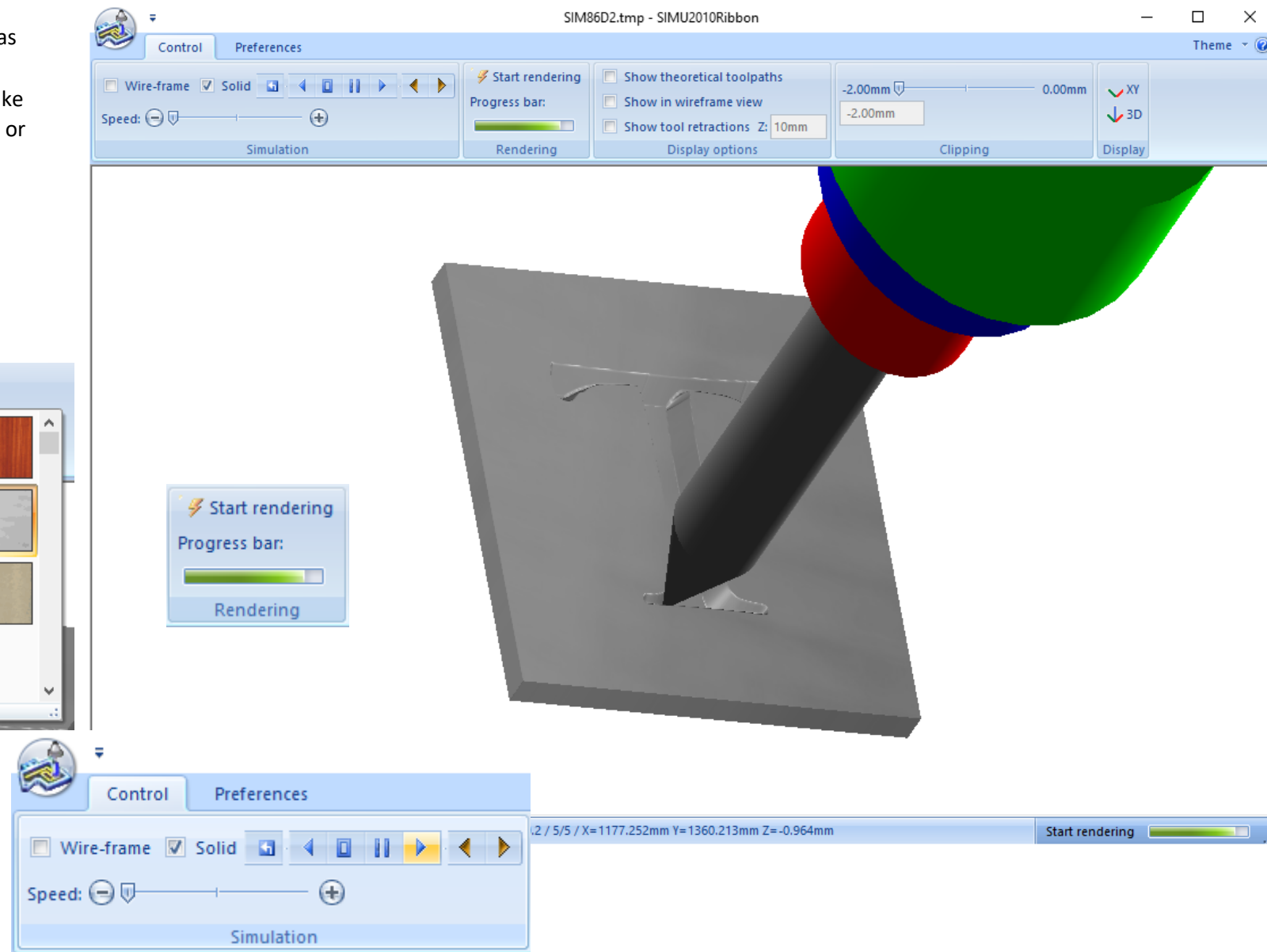
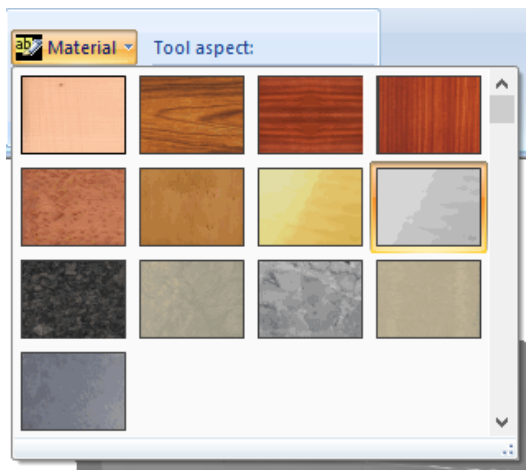

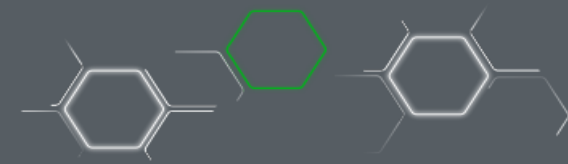



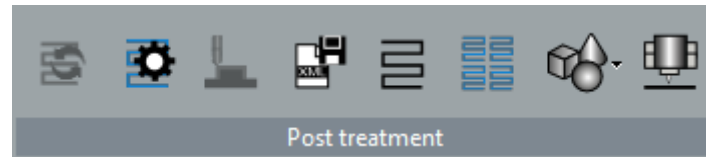



## 4. Post-treatment



8 actions are possible :

- Recalculate a toolpath with the same contours, for example by modifying the tool or the depth, 
- Modify a toolpath with different contours, 
- Insert bridges manually on a Plot or Cutting path, 
- Save machining strategies in XML format for use in a script, 
- Edit the toolpath in the form of curves, 
- Multi copy of a toolpath, 
- Use projection and/or wrapping tools, 
- Finally, start machining

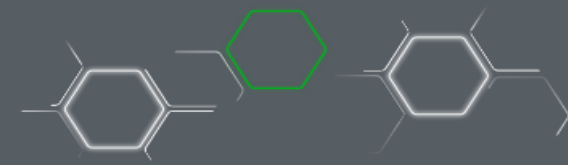

## A. Bridge Insertion Manually



With a "Plotting" or "Cutting" toolpath, it is possible to manually insert bridges to prevent workpieces from falling out during machining.

In the interface, the user will be able to :

- Manually insert the position of the bridges as well as the dimensions of the bridge (height and width),
- Define a total number of bridges per contour or a minimum and maximum number,
- Define curved bridges,
- Clear all bridges

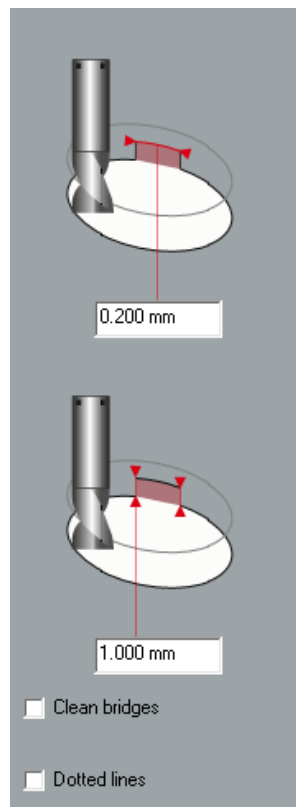

Curved bridges

Insert bridges on selection

Delete all bridges

Bridges and Tangential Entry/Exit

File Edit View Tangential Entry/Exit Bridges

Clean bridges  
 Dotted lines

Clean bridges  
 Dotted lines

Bridges parameters

Bridge length:

Bridge height:

**Set**

distance:

Min:

Max:

number:

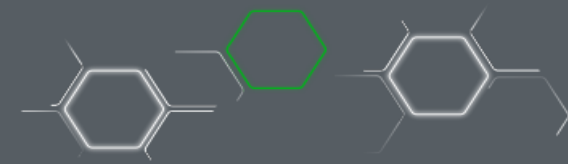

## B. Saving paths in XML

Select a tool path and then click on the Save as XML icon. Fill in the name. The created XML file can be used later in the scripts.

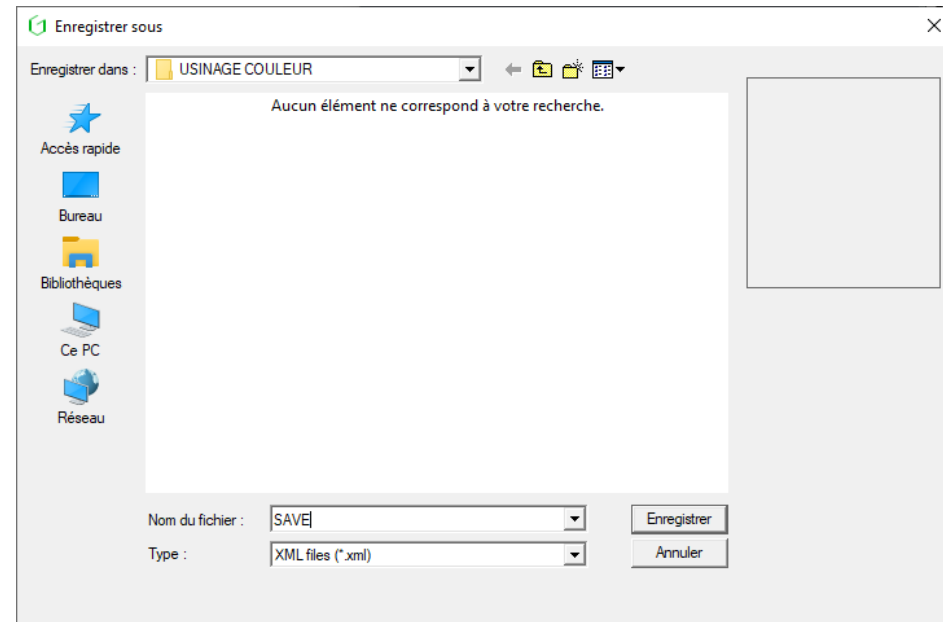
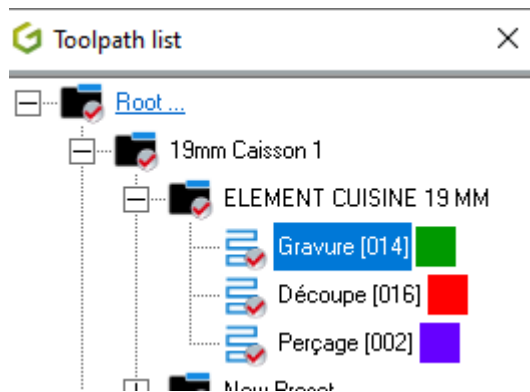

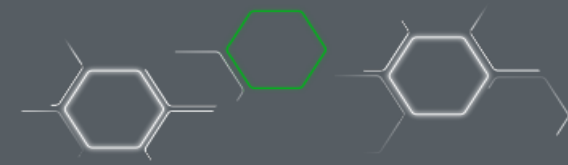

### C. Editing the toolpath in vector geometry



With TYPE CAM, you can edit the toolpath as vectors and then make checks in point mode, circular duplication, or other interesting actions in TYPE CAD.

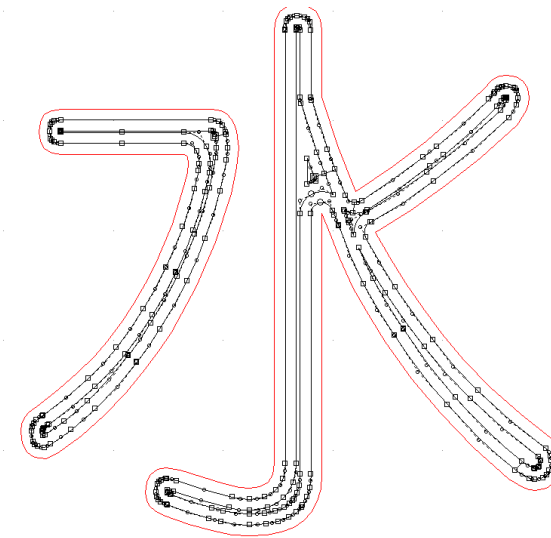
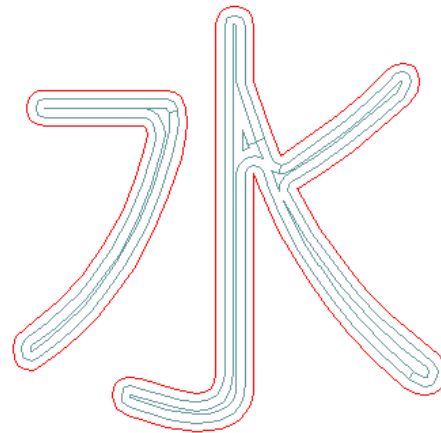
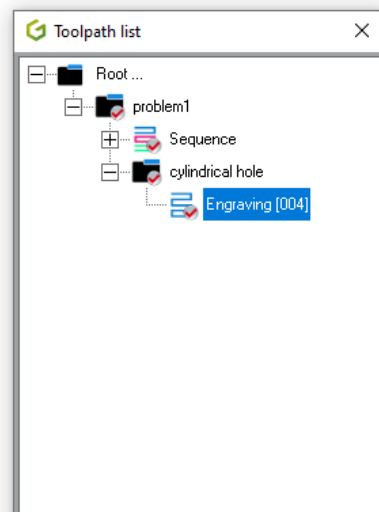

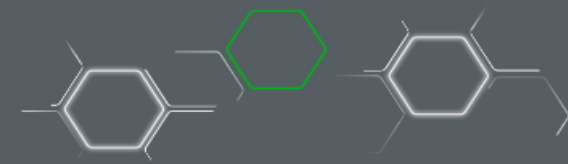

### D. Multi copy of a toolpath



This very interesting function allows you to duplicate a toolpath in matrix form. You can specify the number of copies in row / column as well as the spacing between the parts. Keep or not the original and change the reference point for the duplication.

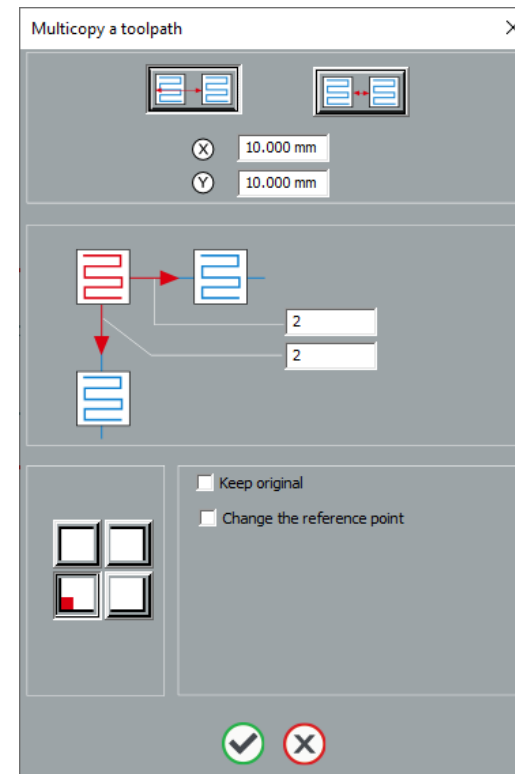

### E. Use projection and/or wrapping tools



Depending on your configuration, you will also be able to use the projection and/or wrapping tools.:



**Note :** Please have a look at the help to see how these functions work, which allow you to place any toolpath on any surface.

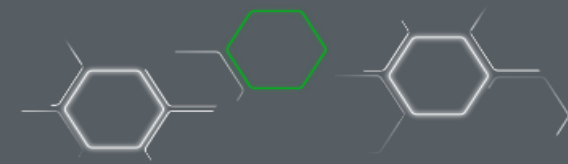

## F. Start milling

This is the last step which consists of creating the code and sending it to the machine. You can manage the safety distance between 2 objects, make shifts according to the origin of your machine, make mirrors, or activate specific commands for your machine.

**Machining** [Close]

COBALM - IDEA Plus (r2.01)

Test  
  Post  
  File  
 C:\DOCUMENTS Path...



ABC ✓ OBA ABC ABC

ABC ABC ABC YBA

Toolpath sel... Multi Z...

Collate... Parameters...

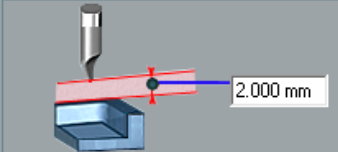

2.000 mm

	Min.	Med.	Max.	Delta
<b>X</b>	311.257 mm	323.099 mm	334.941 mm	23.685 mm
<b>Y</b>	26.604 mm	38.195 mm	49.786 mm	23.182 mm
<b>Z</b>	-0.200 mm	-0.200 mm	-0.200 mm	0.000 mm

OK Spooler...

Run More...

Cancel About



**Test** [Close]

```

----- Begin file -----
:
: DATE .. : 25/02/2021 - 16:45:37
: FILE .. : <<ON TEST>>
: PROC: COB_01 - 02.02.06
:
: !1 SBC 0 d
$1
VEL X0 Y0 Z0
ACC X0 Y0 Z0
SCZ X0.00 Y0.00 ZV32
SEV W16 0.00
MLT W16 100
SEV W17 0.00
MLT W17 100
SEV W13 100.00
MLT W13 100
SEO 110
WTT 110
SEV W200 1
CAL 101
MOV Z-5.00
    
```

Close